



tabbies®

Healthcare Filing, Indexing & Labeling Products

simple solutions @ work®



table of contents

PRACTICE MARKETING/GIVEAWAYS4

- children's stickers4
- medical information cards4
- temporary tattoos4

PATIENT CHART INDEX TABS & DIVIDER SHEETS5 - 8

- admission index tabs & divider sheets7
- divider sheets5
- erasable write-on index tabs7
- index tab filebacks & dividers - custom6
- patient chart index divider sets7
- patient chart index tabs5
- tabs-u-create & divider sheets8

FORMS9

- HCFA/CMS 1500 claim forms9
- patient sign-in label forms9
- pharmacy integrated label forms9

FILE FOLDERS10 - 11

FILING ACCESSORIES 5 - 13, 26

- cd saver™ sleeve protectors 17
- color code filing made easy 26
- conversion products 12
- digi-strip® flash drive 17
- divider sheets5
- expanding divider pockets 16
- fastener positioning guide13,19
- fasteners 13
- fileback dividers 11
- installation solutions - custom 19
- lock-it pockets 16
- name label protectors/page edge reinforcers ... 15
- outguides 18
- poly & vinyl pockets 16
- reinforcing strips 17
- self-adhesive divider sheets 11

LABELS4 - 25

- blank strip labels 20
- children's stickers4
- col'r'tab II refill labels 20
- communication labels 22 - 25
- file folder labels 14
- labels - custom 19
- labels-u-create 8, 20
- laser/inkjet file folder labels 14
- laser/inkjet label sheets 21
- medical information cards4
- medical transcription labels9
- pharmacy integrated label forms - custom9
- temporary tattoos4
- wrap-around file folder labels 14

COLOR CODE LABEL SYSTEMS27 - 43

- color code filing made easy 26
- Acme Visible® Compatible 31, 41
- alpha 31
- numeric 31
- yearcode 41
- Ames® Compatible 39, 41
- numeric 39
- yearcode 41
- Barkley® Compatible 32, 42
- alpha 32
- numeric 32
- yearcode 42
- Original Col'R'Tab® 27 - 30, 40, 41, 42
- alpha 27 - 30
- designator 40
- double digit 29
- month 29
- numeric 27 - 30
- yearcode 41, 42
- Colwell® Compatible 33, 42
- alpha 33
- numeric 33
- yearcode 42
- GBS/VRE® Compatible 33 - 34, 42
- alpha 33 - 34
- numeric 33 - 34
- yearcode 42
- Jeter® Compatible 30, 34, 35, 39, 42
- alpha 30, 34, 35
- designator 39
- numeric 35
- yearcode 42
- Kardex® Compatible 31 - 32, 40
- alpha 31
- numeric 32
- designator 40
- Medical Arts Press® Compatible 42
- yearcode 42
- PMA® Compatible 43
- yearcode 43
- POS® Compatible 35
- alpha 35
- Safeguard® Compatible 30
- alpha 30
- SFI® Compatible 39, 41
- numeric 39
- yearcode 41
- Smead® Compatible 36, 37, 43
- alpha 36, 37
- numeric 36, 37
- yearcode 43
- Tab Products® Compatible 34, 37, 38, 43
- alpha 34, 37, 38
- numeric 34, 37, 38
- yearcode 43
- Original Tabbies® 38, 39, 41
- alpha 38
- designator 39
- month 38
- numeric 38
- yearcode 41

numerical stock index

11000 - 11009.....	27	41020	37	71010	37	97115 - 97615.....	43
11015	27 - 39	41800	36	71020	37	97116 - 97616.....	43
11050 - 11059.....	28	41820	36	71021 - 71047.....	37	97117 - 97617.....	43
11100 - 11113.....	40	42000	27	71100 - 71109.....	34	97118 - 97618.....	43
11190 - 11199.....	29	42030	27	71110	34	97119 - 97619.....	43
11200	29	42100	28	71120	34	97120 - 97620.....	43
11500 - 11509.....	28	49401 - 49406.....	14	71121 - 71147.....	34	MAP1000	23
11600 - 11613.....	40	49430	21	71200 - 71209.....	38	MAP1110	25
11713 - 11723.....	41	49431 - 49443.....	14	71221 - 71246.....	38	MAP1160	25
11830 - 11842.....	29	51713 - 51723.....	41	71520	35	MAP1170	25
11850 - 11862.....	29	52100	5	71521 - 71547.....	35	MAP1180	22
11881 - 11892.....	29	52102 - 52123.....	5	71600 - 71609.....	32	MAP1310	25
12000	27 - 37	53110	40	71620	32	MAP1320	22
12001 - 12042.....	27	53300 - 53310.....	40	71621 - 71647.....	32	MAP1350	22
12101 - 12127.....	28	53500 - 53510.....	40	71713 - 71723.....	41	MAP1460	25
12500 - 12509.....	31	53520 - 53521.....	5	71821 - 71846.....	36	MAP1480	25
12613 - 12623.....	41	54460	16	74500 - 74504.....	18	MAP1510	23
12701 - 12714.....	31	54470 - 54471.....	16	74520	18	MAP1540	22
12800 - 12809.....	39	54492 - 54499.....	16	74530 - 74534.....	18	MAP1570	25
12913 - 12923.....	41	54500	7	74540 - 74544.....	18	MAP1630	23
138-0 - 138-9.....	32	54505	7	74559	18	MAP167	23
139-A - 139-Z	31	54519 - 54520.....	5	74580 - 74585.....	18	MAP1730	23
140-0 - 140-9.....	32	54521 - 54584.....	5	74590 - 74591.....	18	MAP2220	22
14000 - 14009.....	37	54651 - 54652.....	4	81000 - 81009.....	27	MAP2830	25
14101 - 14127.....	37	55990 - 55996.....	12	81500 - 81509.....	28	MAP2940	25
142	31	56012 - 5601213	10	81713 - 81723.....	41	MAP2950	25
143	31	56015 - 5601513	10	81951 - 81976.....	29	MAP3080	25
14413 - 14423.....	42	56018 - 5601813	10	82001 - 82042.....	27	MAP3090	25
144-A - 144-Z	31	56019 - 5601913	10	82051 - 82077.....	28	MAP3220	23
14500	7	56022 - 56024.....	10	82101 - 82127.....	28	MAP3230	23
14501 - 14512.....	7	56025 - 5602513	10	84101 - 84127.....	37	MAP3250	23
14530 - 14532.....	9	56055 - 5605513	10	88385	15	MAP327	23
14540	9	56058 - 5605813	10	88485	15	MAP3300	23
14560 - 14569.....	30	56222 - 5622213	10	90100 - 90109.....	38	MAP3350	24
14600 - 14609	34	566001	10	90110	32 - 38	MAP3390	24
14611 - 14637.....	34	567601	10	90121 - 90146.....	38	MAP3410	22
14713 - 14723.....	42	56804	13	90150	30, 32 - 38	MAP343	22
14913 - 14923.....	41	56805	13	90413 - 90423.....	42	MAP345	22
20001 - 20010.....	4	56807	13	90513 - 90523.....	42	MAP3500	22
20100	4	56809	13	90613 - 90623.....	42	MAP3530	22
21813 - 21823.....	43	56811 - 56812.....	13	90813 - 90823.....	43	MAP3550	22
25100 - 25101.....	17	56820	13	90913 - 90923.....	43	MAP4200	25
26330 - 2633013	11	58385 - 58385B	15	91000 - 91009.....	37	MAP4220	22
26360	11	58390	17	91010	37	MAP4500	22
26370	11	58392	17	91020	37	MAP4790	22
26372	11	58485	15	91021 - 91047.....	37	MAP488	23
26808	13	58530	7	91100 - 91109.....	34	MAP4890	24
28401	4	58600 - 58610.....	7	91121 - 91147.....	34	MAP4900	23
28451	4	58700 - 58710.....	7	91213 - 91223.....	43	MAP496	24
28471	4	58727	7	91300 - 91309.....	33	MAP5180	22
30010 - 30011.....	20	58800 - 58810.....	7	91310	33	MAP6420	25
31000	27	58900 - 58910.....	7	91320	33	MAP6440	23
31100	34	59430 - 59443.....	14	91321 - 91347.....	33	MAP6470	22
31120	34	59513	9	91400 - 91409.....	33	MAP7130	24
31600	32	59530 - 59534.....	9	91410	33	MAP7190	24
31620	32	61021 - 61047.....	37	91420	33	TP240-A - TP240-MC	37
31920	36	61321 - 61347.....	33	91421 - 91447.....	33	UL007	25
31950	29	61421 - 61447.....	33	91500 - 91509.....	35	UL1423	25
32000	27	61521 - 61547.....	35	91520	35	UL520	25
32030	27	61721 - 61747.....	30	91521 - 91547.....	35	UL702	24
32100	28	62231 - 62240.....	35	91566	35	UL808	24
34651 - 34652.....	4	62241 - 62267.....	35	91600 - 91609.....	32	UL926	24
40100 - 40103.....	8, 20	63021 - 63047.....	30	91621 - 91647.....	32	UL927	23
40120 - 40123.....	8, 20	68386	15	91721 - 91747.....	30		
40140 - 40143.....	8, 20	68387	15	91800 - 91809.....	36		
40150 - 40165.....	21	70213 - 70223.....	41	91821 - 91846.....	36		
40200 - 40202	8	70231 - 70242.....	38	91921 - 91933.....	36		
40524 - 40531.....	22	70243	38	91981 - 91993.....	39		
40560 - 40562.....	23	70513 - 70523.....	41	92013 - 92023.....	43		
40566	22	70521 - 70533.....	39	93021 - 93047.....	30		
40570 - 40574.....	24	70813 - 70823.....	43	94613 - 94623.....	42		
41000	27	71000 - 71009.....	37	94900 - 94909.....	39		

practice marketing/giveaways

stickers & temporary tattoos

stickers and temporary tattoos are a fun way to promote learning, motivate and reward children. Great as patient giveaways.



stock no.	description	qty. per pkg.	qty. per box
28401	VeggieTales® Character Stickers	24/pkg.	10 pkgs./box
28451	VeggieTales® Temporary Tattoos	16/pkg.	10 pkgs./box
28471	VeggieTales® Scratch'n'Smell Stickers	54/pkg.	10 pkgs./box
28501	Aetherlight Character Stickers	24/pkg.	10 pkgs./box
28502	Aetherlight Action Stickers	24/pkg.	10 pkgs./box

medical information cards

ICE Medical Alert Card and MED Card are the size of a credit card and are perfect as giveaways for; Doctors' Offices, Hospitals, Retirement Homes/Extended Care Facilities, College Admissions Packets, New Hire Packets, And Much More. These useful cards allow the individual to fill in pertinent medical information that can then be stored in a wallet in case of emergency or for quick reference. ICE Medical Alert Card and MED Card have a laminating seal to protect the written information and eliminate smudging. Folded together, the card is strong, durable and water resistant. Empty displays available.



The cards are also customizable to fit your business needs. Contact Customer Service for a Quote.

stock no.	description	size	qty. per pkg.	qty. per box
54651	ICE Medical Alert Card	3-3/8" w x 2-1/8" h	25/pkg.	4 pkgs./box
54652	MED Card	3-3/8" w x 2-1/8" h	25/pkg.	4 pkgs./box
34651	ICE Medical Alert Card Counter Display	3-1/8" d x 2-3/4" w x 9-1/8" h	-	150/display
34652	MED Card Counter Display	3-1/8" d x 2-3/4" w x 9-1/8" h	-	150/display

children's stickers

These children's stickers are a fun way to make your young patients feel special after each visit.

Roll Kit 20100 Please specify your five rolls at the time of order.



stock no.	description	size	qty. per roll	qty. per unit
20001	#1 Patient Dino	1-3/4"	100/roll	
20002	I Grew This Much	1-3/4"	100/roll	
20003	I'm Healthy Cat	1-3/4"	100/roll	
20004	Star Patient	1-3/4"	100/roll	
20005	I'm a Princess	1-3/4"	100/roll	
20006	Superstar Patient	1-3/4"	100/roll	
20007	#1 Patient Car	1-3/4"	100/roll	
20008	Toad-Ally Great	1-3/4"	100/roll	
20009	Great Checkup	1-3/4"	100/roll	
20010	I'm Cavity Free	1-3/4"	100/roll	
20100	Unit - choose 5 rolls	13-1/2" w x 4" h		5 rolls

patient chart index tabs

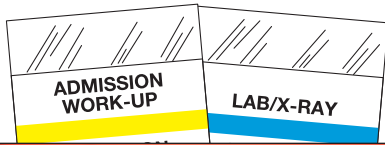

Create your own titles and colors. Contact us for more details.



Let us do your tab attaching for you. See Page 19

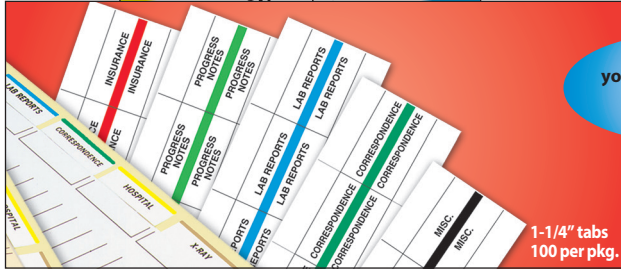

1-1/4" tabs
100 per pkg.

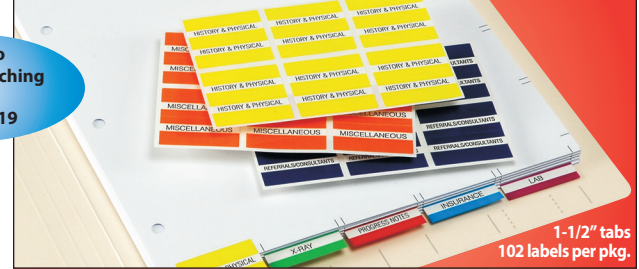

1-1/2" tabs
102 labels per pkg.

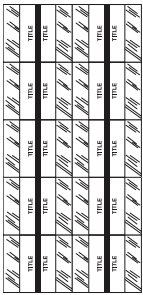

stock no.	title	color
54521	ADMISSION WORK-UP	Yellow
54523	CONSULTS	Green
54524	CORRESPONDENCE	Green
54525	EKG	Red
54546	HIPAA	Red
54528	HISTORY & PHYSICAL	Orange
54544	HOSPITAL	Yellow
54529	INSURANCE	Red
54530	LAB REPORTS	Lt. Blue
54531	LAB/X-RAY	Lt. Blue
54532	MEDICATIONS	Lt. Green
54533	MISC.	Black
54534	NURSES NOTES	Gray
54535	OPERATIVE REPORT	Yellow
54537	PATHOLOGY RESULTS	Green
54538	PHYSICIANS ORDERS	Gold
54539	PROGRESS NOTES	Lt. Green
54542	X-RAY	Tan
54543	X-RAY-EKG	Tan

stock no.	title	color edge
52102	BILLING	Black
52103	CORRESPONDENCE	Brown
52104	DOCTOR'S ORDERS	Gray
52106	FINANCIAL DATA	Lime Green
52107	HISTORY & PHYSICAL	Lt. Yellow
52109	INSURANCE	Lt. Blue
52110	LAB	Purple
52114	MEDICATION	White
52115	MISCELLANEOUS	Orange
52116	PAP SMEAR	Salmon
52117	PATIENT DATA	Lavender
52118	PHYSICAL THERAPY	Bronze
52119	PROGRESS NOTES	Red
52120	REFERRALS/CONSULTANTS	Dk. Blue
52121	SURGERY	Turquoise
52122	WORKER'S COMP	Dk. Purple
52123	X-RAY	Lt. Green

divider sheets

divider sheets are 8-1/2" x 11", 110 lb. white index stock printed with guidelines for fast and accurate placement of the **52100 series** chart divider index tabs. 7-hole punched to be used with fasteners or 3-ring binders.

stock no.	description	qty.
52100	110 lb. white	100/pkg.

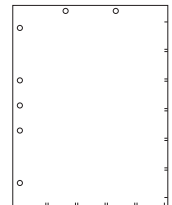

54522	ALLERGY	Red
54552	CONSENT FORMS	Lt. Green
54553	DIAGNOSTIC	Yellow
54547	HEALTH HISTORY	Dk. Blue
54558	IMMUNIZATION	Dk. Blue
54561	MEDICAID	Lt. Blue
54562	MEDICARE	Lt. Green
54569	PATIENT INFORMATION	Orange
54571	PHYSICAL THERAPY	Orange
54573	PRESCRIPTION	Red
54540	REFERRALS	Dk. Blue
54577	SURGICAL	Yellow
54580	TREATMENT PLAN	Tan
54589	WRITABLE	White

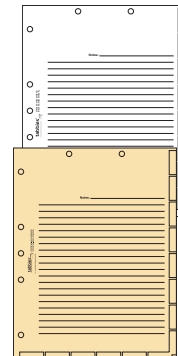
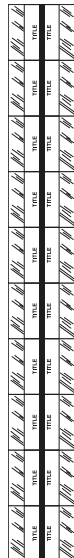

divider sheets are 8-1/2" x 11", 110 lb. index stock printed with guidelines for fast and accurate placement of the **54520 series** chart divider index tabs. Sheets are conveniently ruled for making notes and are 7-hole punched to be used with fasteners in folders or 3-ring binders.

stock no.	description	qty.
53520	110 lb. white	100/pkg.
54520	110 lb. white	400/box
54519	110 lb. manilla	100/pkg.
53521	110 lb. manilla	400/box

custom index tab filebacks & dividers

Custom Index Tab Dividers

custom index tab dividers are the cost-effective choice for organizing important papers within your file folder or binder. From medical charts to legal folders or overall general filing, using **custom index tab dividers** allows for quick access to information in a wide range of applications. Choose your own tab titles, color selection, and style that will fit your budget and filing needs.

CUSTOM INDEX

Easy Ordering Instructions:

- Specify paper weight and divider color:
 - 90 lb. or 110 lb.
 - White or ivory (manila) stock
- Choose tab print style and punch hole positions:
 - Side or bottom tabs
 - 5, 3, or 2 hole punch
- Specify tab cut size and tab extension
- List tab titles, positions, and colors
- Choose packaging options:
 - Collated / titles boxed together in sets
 - Non-Collated / each title boxed individually

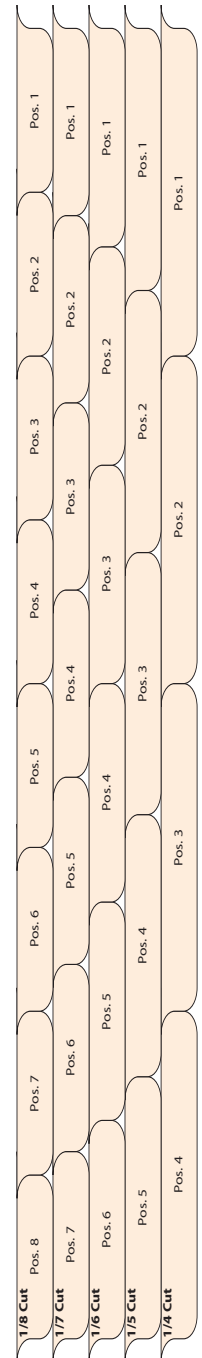
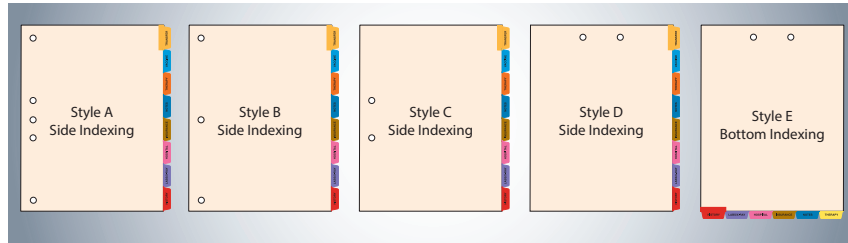

Custom Fileback Dividers

custom fileback dividers take file organization one step further. Each section is self-contained and information can be easily removed without disturbing other sections. Each **custom fileback divider** has a permanent heat-bonded fastener applied to the top or side of the divider allowing for easy and quick retrieval of information.

CUSTOM FILEBACK

Easy Ordering Instructions:

- Specify side or bottom tabs
- Choose fastener: top or side
- Specify style:
 - hinge or self-adhesive
- List tab positions, titles, and colors
- Choose packaging options:
 - Collated / titles boxed together in sets
 - Non-Collated / each title boxed individually

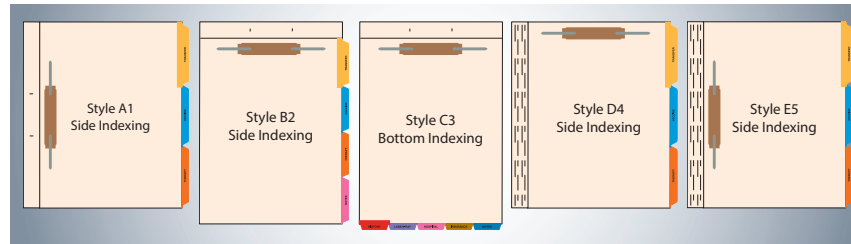

TAB TIP: Plan ahead! Allow for expansion and add a write-on erasable tab to use for your specific office needs.

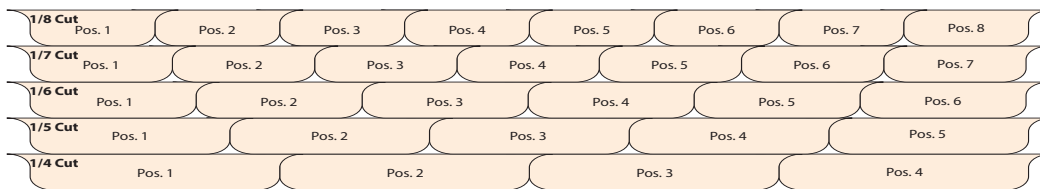
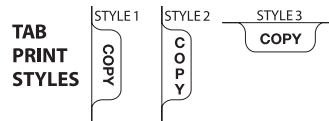

AVAILABLE COLORS:

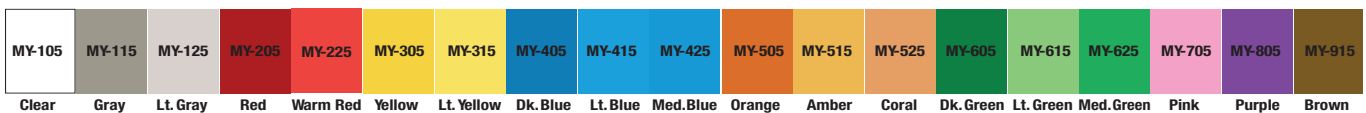

Custom Divider Applications Include:

- ◆ Banking and Financial Records
- ◆ Medical Records
- ◆ Insurance Offices
- ◆ Hospital Patient Charts
- ◆ Spiral Bound Books
- ◆ Employee Handbooks
- ◆ Mortgage Loan Files
- ◆ Product Catalogs
- ◆ Manuals
- ◆ Price Books/Lists
- ◆ Telephone Directories
- ◆ Instruction Manuals
- ◆ Legal Briefs
- ◆ Sales Presentations

Save Time & Money
by letting us install
dividers in your file folders

patient chart index divider sets

Use **tabbies patient chart index divider sets** to organize patient charts, files, or records. Sets come collated. Minimum Purchase: 40 sets (1 box). **No tab substitutions. Contact us for custom sets.**

Sets consist of the following tabs:

Tab Position	Title	Tab Color
1	HISTORY & PHYSICAL	Blue
2	PROGRESS NOTES	Yellow
3	CORRESPONDENCE	Orange
4	LAB/X-RAY	Green
5	HOSPITAL	Red
6	INSURANCE	Gold
7	MISCELLANEOUS	Pink
8	BLANK WRITE-ON	White

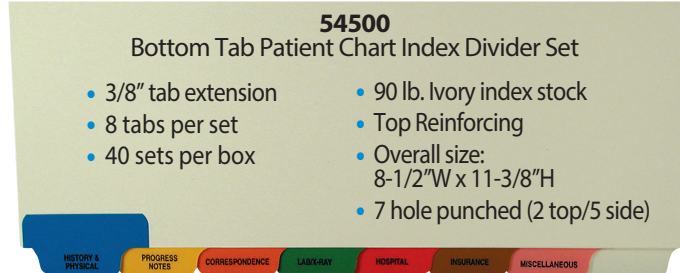

stock no.	description	tab ext.	Overall size	UOM
54500	Bottom Tab Patient Chart Index Divider Set	3/8"	8-1/2" x 11-3/8"	40 Sets/Bx
54505	Side Tab Patient Chart Index Divider Set	1/2"	9" x 11"	40 Sets/Bx

54505
Side Tab Patient Chart Index Divider Set

- 1/2" tab extension
- 8 tabs per set
- 40 sets per box
- 90 lb. Ivory index stock
- Side Reinforcing
- Overall size: 9"W x 11"H
- 7 hole punched (2 top/5 side)

admission index tabs & divider sheets

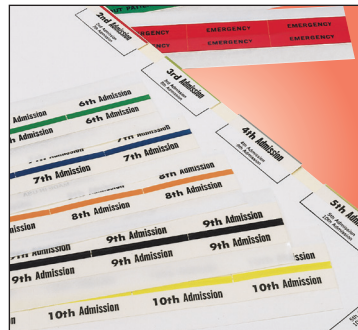

admission index tabs and **divider sheets** make indexing of admission files easy and economical. No more wasted pre-tabbed and numbered divider sheets. Tabs are easily attached to position marks on the 8-1/2" x 11" four-hole punched divider sheets. Admission index tabs and divider sheets can be used for either side or top fastened medical record folders. Self-adhesive 1-1/2" tabs are plastic laminated. 100 per package.

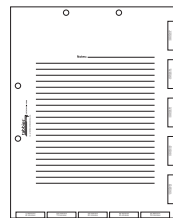

stock no.	title	color edge	stock no.	title	color edge
14501	1st Admission	Light Blue	14507	7th Admission	Blue
14502	2nd Admission	Red	14508	8th Admission	Orange
14503	3rd Admission	Light Green	14509	9th Admission	Black
14504	4th Admission	Gray	14510	10th Admission	Yellow
14505	5th Admission	Gold	14511	EMERGENCY	Red (solid)
14506	6th Admission	Green	14512	OUTPATIENT	Green (solid)

tabbies has a variety of **index divider sheets** in stock or we can customize to accommodate any tab size for your filing needs.

stock no.	description (400 sheets per box)
14500	4-hole punched Admission Index Divider Sheets

erasable write-on index tabs



erasable write-on index tabs can be used over and over again. Write with pencil or any erasable ink pen – then just erase and reuse. Tabs have 1/2" tab extension with colored edges or solid color fluorescent tabs. Ideal for any filing, flagging or indexing situation.



color edge	1" 24 tabs/pkg.	1-1/2" 16 tabs/pkg.	2" 12 tabs/pkg.	3" 8 tabs/pkg.	pkgs./box
Yellow	58600	58700	58800	58900	10
Red	58602	58702	58802	58902	10
Green	58606	58706	58806	58906	10
Blue	58607	58707/58727	58807	58907	10
Black	58609	58709	58809	58909	10
White	58610	58710	58810	58910	10

Assorted Solid Colors	stock no.	color	size	tabs/pkg.	pkgs./box
	58530	Fluorescent	1-1/2"	24	10

tabs-u-create & divider sheets



Use your laser printer and Microsoft Word® with **tabs-u-create** to make custom title indexes in seconds. Self-adhesive tabs are 1-1/4" in length and grip both sides of the page for added strength. Easy set-up instructions come inside each package of index tabs. Use **tabs-u-create divider sheets** to make full index dividers. Tabs have 1/2" tab extension in white or assorted colors. For bottom or side indexing.

stock no.	color	tab size	tabs/sheet	tabs/pkg.
40201	White	1-1/4"	12	60
40202	Assorted	1-1/4"	12	60

tabs-u-create divider sheets

tabs-u-create divider sheets have position marks for easy placement of index tabs. For bottom or side indexing.

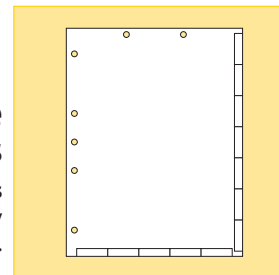

Create Indexes in Seconds!

stock no.	sheet size	sheets/pkg.
40200	8-1/2" w x 11" h	50

labels-u-create



Create bright, eye-catching communication labels in seconds, using your PC and laser printer with **labels-u-create** to make custom labels for any application. Permanent labels can be applied to folders, documents, drawers, even shelving. Make an entire sheet of the same label or just a few at a time. Easy set-up instructions inside. Works with Microsoft Word® No additional software is needed. 10 (8-1/2"x11") sheets per package. Available in 3 colors plus white.

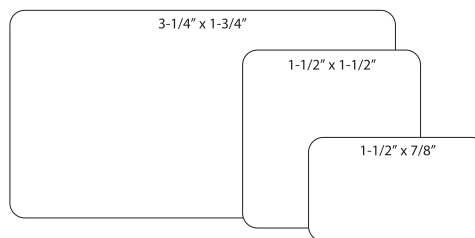

stock no.	label size	color	labels/sheet	labels/pkg.
40100	1-1/2" X 7/8"	White	32	320
40101	1-1/2" X 7/8"	Fl. Red	32	320
40102	1-1/2" X 7/8"	Fl. Green	32	320
40103	1-1/2" X 7/8"	Fl. Yellow	32	320
40120	1-1/2" X 1-1/2"	White	20	200
40121	1-1/2" X 1-1/2"	Fl. Red	20	200

stock no.	label size	color	labels/sheet	labels/pkg.
40122	1-1/2" X 1-1/2"	Fl. Green	20	200
40123	1-1/2" X 1-1/2"	Fl. Yellow	20	200
40140	3-1/4" X 1-3/4"	White	10	100
40141	3-1/4" X 1-3/4"	Fl. Red	10	100
40142	3-1/4" X 1-3/4"	Fl. Green	10	100
40143	3-1/4" X 1-3/4"	Fl. Yellow	10	100

medical transcription labels

laser printer transcription labels

Trouble-free **laser sheets** pass through your laser printer without jamming. Perforated backs and 1/4" margins allow for easy detaching. White.

stock no.	label size	full sheet size	qty. per box	qty. per carton
59530	1" strips, perf-thru	8-1/2" x 11"	100	
59531	2" strips, perf-thru	8-1/2" x 11"	100	
59532	3-1/2" strips, perf-thru	8-1/2" x 11"	100	
59533	11" full sheet	8-1/2" x 11"	100	
59534	11" full sheet	8-1/2" x 11"		1000

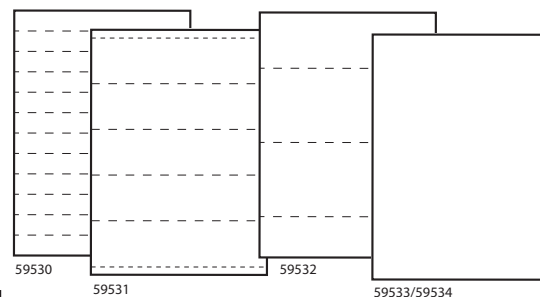

pin feed transcription labels

High quality **pin feed labels** are formatted on continuous fan-folded sheets. White.

stock no.	label size	full sheet size	qty. per box
59513	7-5/8" fan-folded	8-5/8" x 12"	208

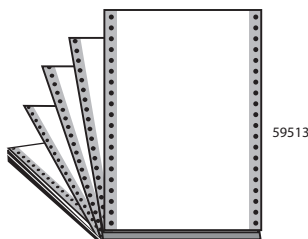

patient sign-in label forms

Confidentially sign in your patients with **patient sign-in label forms**. Forms limit access to personal information as required by HIPAA compliance regulations. Patients sign in on next available removable numbered label strip. Patient then takes the numbered label and waits to be called by name or number. Office staff removes numbered label strip with patient name and adheres it to patient chart to help improve recordkeeping. Once label strips have been removed, the patient information is now protected behind special backing paper. The Sign-In form also provides a confidential daily patient log.

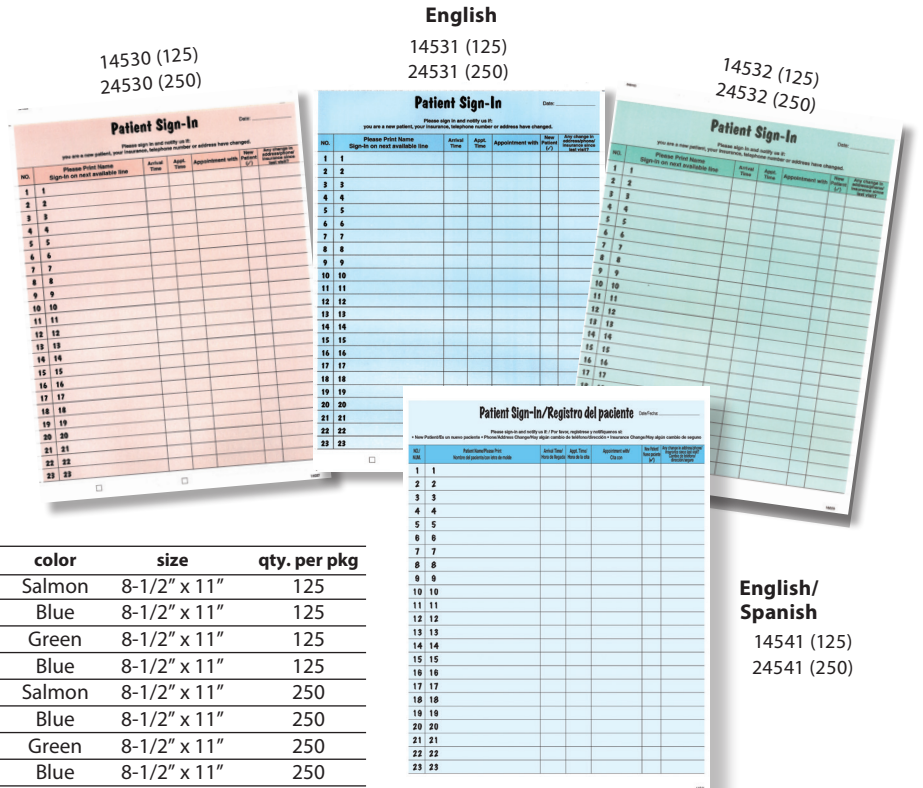

stock no.	description	color	size	qty. per pkg
14530	Patient Sign-In Label Form	Salmon	8-1/2" x 11"	125
14531	Patient Sign-In Label Form	Blue	8-1/2" x 11"	125
14532	Patient Sign-In Label Form	Green	8-1/2" x 11"	125
14541	Bilingual Patient Sign-In Label Form-Spanish	Blue	8-1/2" x 11"	125
24530	Patient Sign-In Label Form	Salmon	8-1/2" x 11"	250
24531	Patient Sign-In Label Form	Blue	8-1/2" x 11"	250
24532	Patient Sign-In Label Form	Green	8-1/2" x 11"	250
24541	Bilingual Patient Sign-In Label Form-Spanish	Blue	8-1/2" x 11"	250

HCFA/CMS 1500 claim forms

Speed up third-party billing and manage your cash flow with these HCFA/CMS 1500 claim forms (Health Care Financing Administration/Center for Medicare and Medicaid Services) using your laser printer. Printed with OCR 'dropout' red ink on 20 lb. paper per government regulations. Accommodates NPI numbers as mandated by HIPAA compliance regulations. Includes all updates to the 02/12 version approved by the NUCC (National Uniform Claim Committee).

stock no.	description	size	qty. per pkg
14540	HCFA/CMS 1500 Claim Forms	8-1/2" x 11"	500



pharmacy integrated label forms

Custom **pharmacy integrated label forms** have pressure sensitive labels at the top and bonded paper at the bottom to increase efficiency by reducing the number of steps necessary to complete your task. These forms will improve accuracy by combining multiple document types into one multi-use form. 24 lb. laser sheets can be printed with laser or inkjet printers. Bulk packed 1,500 sheets per carton.

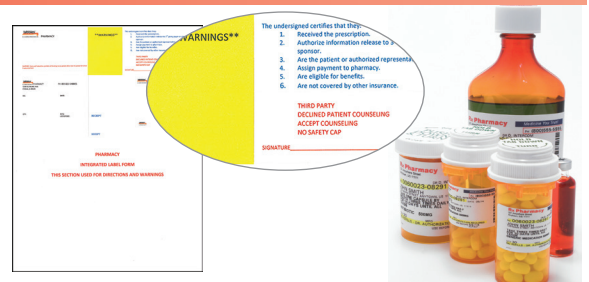

Customizable to fit your business needs.
Contact Customer Service for a Quote.

file folders

**CUSTOM
PRINTED FOLDERS**
Call for quote

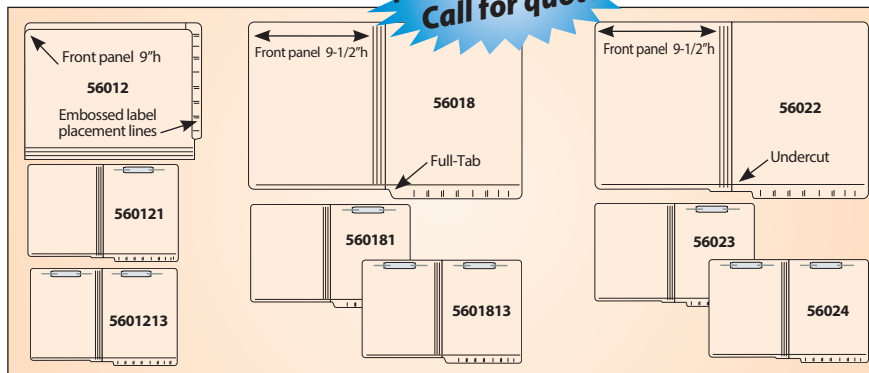

11 pt. 2-Ply (Reinforced) Letter

stock no.	size	folders/case
56012	12-1/4" w x 9-1/2" h	500
560121*	12-1/4" w x 9-1/2" h	250
5601213**	12-1/4" w x 9-1/2" h	250
56018	12-1/4" w x 9-1/2" h	500
560181*	12-1/4" w x 9-1/2" h	250
5601813**	12-1/4" w x 9-1/2" h	250
56022	12-1/4" w x 9-1/2" h	500
56023*	12-1/4" w x 9-1/2" h	250
56024**	12-1/4" w x 9-1/2" h	250

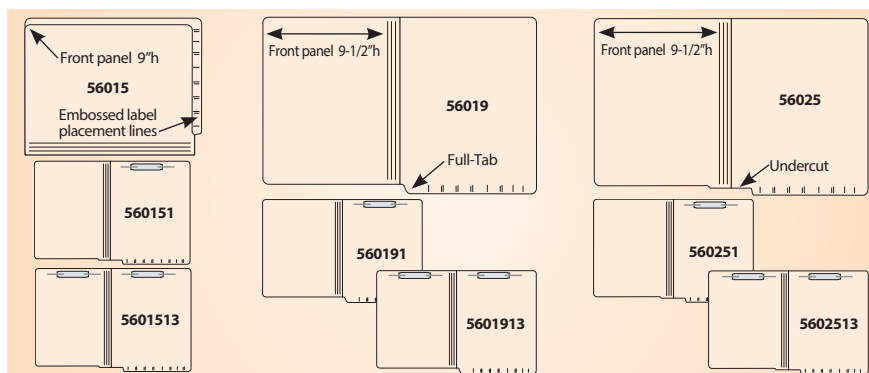

14 pt. 1-Ply Letter

stock no.	size	folders/case
56015	12-1/4" w x 9-1/2" h	500
560151*	12-1/4" w x 9-1/2" h	250
5601513**	12-1/4" w x 9-1/2" h	250
56019	12-1/4" w x 9-1/2" h	500
560191*	12-1/4" w x 9-1/2" h	250
5601913**	12-1/4" w x 9-1/2" h	250
56025	12-1/4" w x 9-1/2" h	500
560251*	12-1/4" w x 9-1/2" h	250
5602513**	12-1/4" w x 9-1/2" h	250

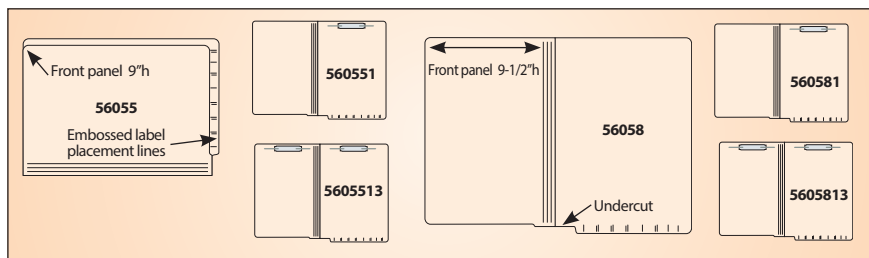

14 pt. 1-Ply Legal

stock no.	size	folders/case
56055	15-1/4" w x 9-1/2" h	500
560551*	15-1/4" w x 9-1/2" h	250
5605513**	15-1/4" w x 9-1/2" h	250
56058	15-1/4" w x 9-1/2" h	500
560581*	15-1/4" w x 9-1/2" h	250
5605813**	15-1/4" w x 9-1/2" h	250

combo drawer/shelf file folder

combination drawer / shelf folder design can be used as top tab in a drawer or as an end tab in an open shelf. Large tab area on top and side allows plenty of room for all your labeling needs.

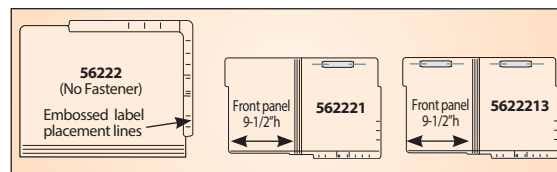

11 pt. 2-Ply (Reinforced) Letter

stock no.	size	folders/case
56222	12" w x 9-1/2" h	500
562221*	12" w x 9-1/2" h	250
5622213**	12" w x 9-1/2" h	250

top straight cut file folder

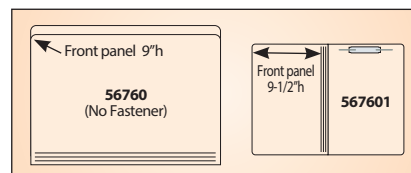
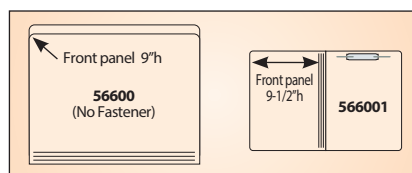

11 pt. 1-Ply Letter

stock no.	size	folders/case
56600	11-3/4" w x 9-1/2" h	500
566001*	11-3/4" w x 9-1/2" h	250

14 pt. 1-Ply Legal

stock no.	size	folders/case
56760	14-3/4" w x 9-1/2" h	500
567601*	14-3/4" w x 9-1/2" h	250

* 1 Fastener applied, POSITION 1

** 2 Fasteners applied, POSITIONS 1 & 3.

Printed label placement lines except where noted.

FASTENER POSITION GUIDE on page 13 & 19.

self-adhesive divider sheets

CUSTOM INDEXING
See Page 6

Quickly convert your standard folders to classification folders. Just fold on the score line to create a flap, then remove protective strip and apply to folder—it's that easy! Sturdy **divider sheets** are 11 pt. manila stock. Die-cuts on flap allow for easy positioning around fasteners. **Divider sheets** come in several options: no fastener, 1 fastener on front of divider, or 2 fasteners on both sides of divider. 8-1/2" w x 11" h (not including flap) – 100 dividers per package.

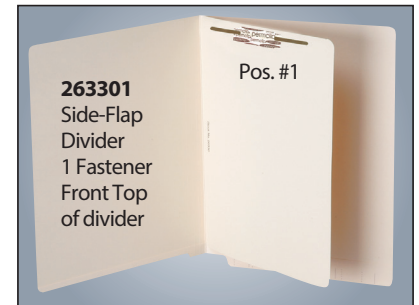

stock no.	fastener(s)
26330	None
263301	1-Fastener Front Top – Pos. #1
263305	1-Fastener Front Side – Pos. #5
2633013	2-Fasteners Top of both sides – Pos. #1 & #3

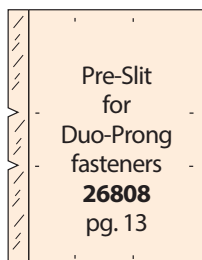
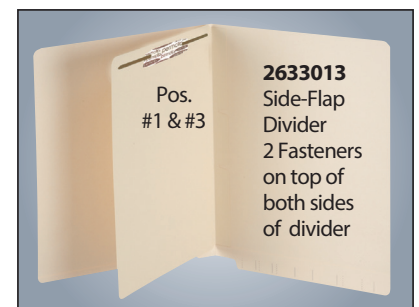
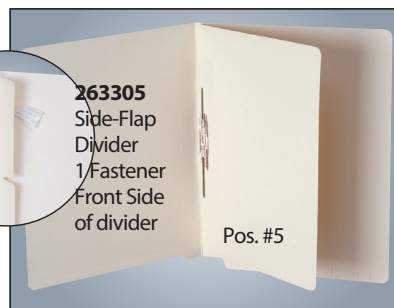

Fold on score line,
peel away backing sheet
and apply to folder

fileback dividers

fileback dividers allow immediate access to each section without removing the top sections from the folder. Each **fileback divider** is scored for easy folding and comes with an installed 2" capacity fastener. Fold score line to form flap and slip divider over existing fastener in folder. The next divider is attached to the fastener on the first divider, and so on. Sturdy 11 pt. manila stock. Available with or without (bottom) end tab cut. 100 dividers per pkg.

stock no.	description
26360	Letter 8-1/2" x 11
26370*	Letter 8-1/2" x 11-3/4"; Left End Tab 1/2 cut
26372*	Letter 8-1/2" x 11-3/4"; Right End Tab 1/2 cut

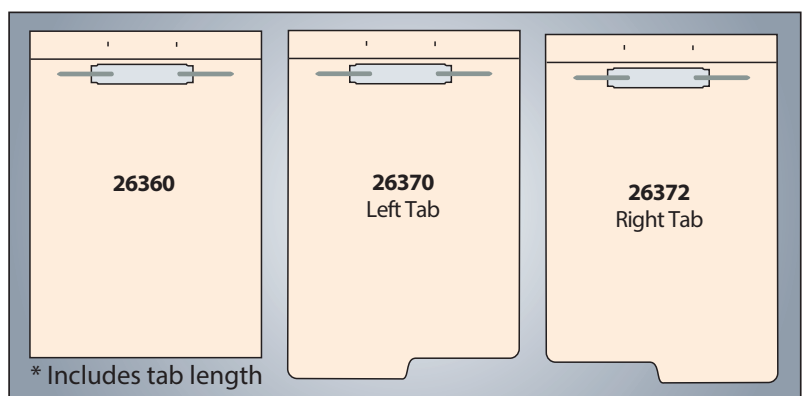

* 1 Fastener applied, POSITION 1

** 2 Fasteners applied, POSITIONS 1 & 3.

Printed label placement lines except where noted.

FASTENER POSITION GUIDE on page 13 & 19.

conversion products

extenda-folder strips

Convert any top tab pocket folders, pressboard folders, or expanding file jackets into end tab file folders. Save the trouble and expense of transferring materials and throwing away good file folders, pockets, and jackets. All conversion strips are self-adhesive and easy to install. Choose from 6 styles to fit your needs.

stock no.	size	tab extension	strips/box
55991	3-1/4"w x 9-1/4"h	1/2"	100
55991B	3-1/4"w x 9-1/4"h	1/2"	1,000
55992	4-3/4"w x 9-1/2"h	3/4"	100
55993	3-1/4"w x 9-1/2"h	3/4"	100

stock no.	size	tab extension	strips/box
55993B	3-1/4"w x 9-1/2"h	3/4"	1,000
55994	2"w x 9-1/2"h	3/4"	100
55995	3-3/4"w x 9"h	3/4"	100
55996	3-3/4"w x 9-1/2"h	1"	100

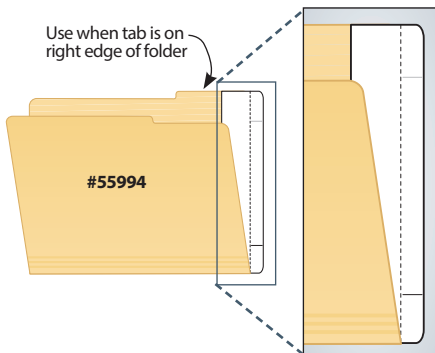

- ◆ 9-1/2"h can be used for any top tab cut folders.
- ◆ Strip is applied inside of the back folder panel.
- ◆ Coding labels can be pre-applied before installation of strip.
- ◆ White stock, 3/4" tab extension, 9-1/2"h.

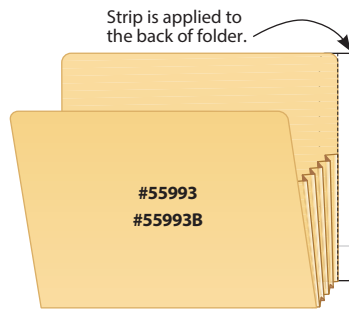

- ◆ Specifically made for pressboard or gusset folders.
- ◆ Coding labels can be pre-applied before installation of strip.
- ◆ White stock, 3/4" tab extension, 9-1/2"h.

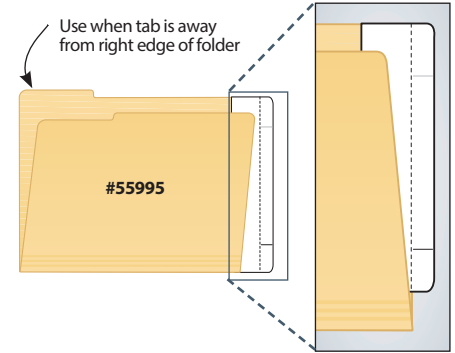

- ◆ 9"h can be used for any top tab cut folders.
- ◆ Strip is applied inside of the back folder panel.
- ◆ Coding labels can be pre-applied before installation of strip.
- ◆ White stock, 3/4" tab extension, 9"h.

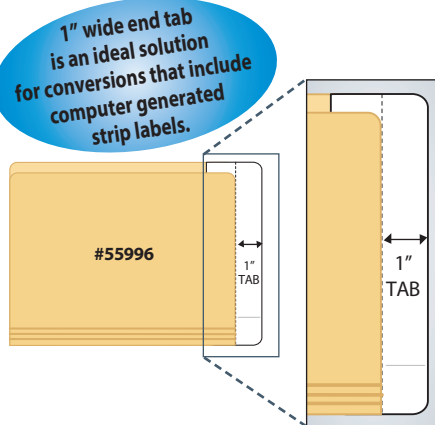

- ◆ Use with any straight cut folder.
- ◆ Strip is applied inside of the back folder panel.
- ◆ Color Coded strip-label can be pre-applied before installation of conversion strip.
- ◆ White stock, 1" tab extension, 9-1/2"h.

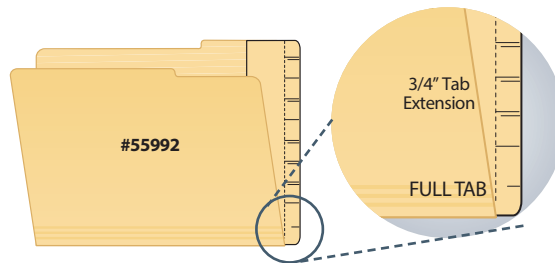

- ◆ Wrap-around design is easy to apply to any top tab folder.
- ◆ Attaches to inside and outside back of folder panel.
- ◆ Manila stock to match your folder.

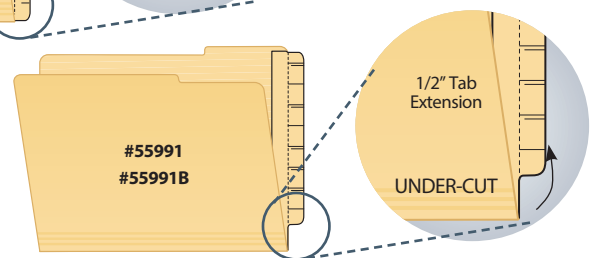

cov'r'tabs

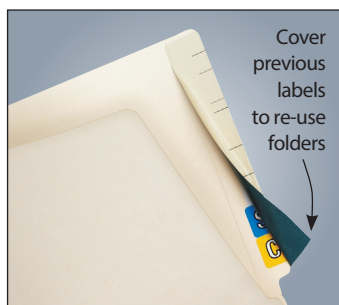

Easy way to re-use old folders. Self-adhesive and wrap-around design adds reinforcement to tab. Printed score marks for even positioning of new labels. 60 lb. in manila color finish. Strip must be applied to folder *before* application of new labels. Opaque feature prevents previous color coding from showing through.

stock no.	size	cov'r'tabs/pkg.
55990	2-1/2"w x 8"h	50

sup'r grip fasteners



Self-adhesive **sup'r grip fasteners** are an ideal space-saving solution for large files. Long 2" prongs accommodate 2-hole punched material, while the ultra-thin design saves valuable filing space. Fasteners are heat bonded onto pressure-sensitive, 60 lb. manila-colored paper to hold even the bulkiest files without tearing. Printed aligning guides on each strip ensure accurate placement. 4 fasteners per sheet; 25 sheets per box.

stock no.	description	fasteners/box
56805	sup'r grip fasteners	100

duo-prong fasteners

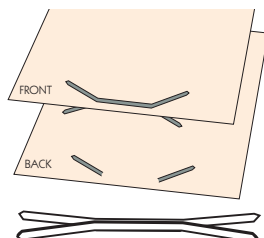

duo-prong fasteners are used when fasteners are required on both the front and back of a divider sheet for 2-hole punched documents. Fastener capacity is 1" on one side and 5/8" on the other. Simply insert 1" prongs thru slits in divider sheet, and bend prongs back. No adhesive required.

stock no.	description	fasteners/box
26808	duo-prong fasteners	100

earflap™ fasteners

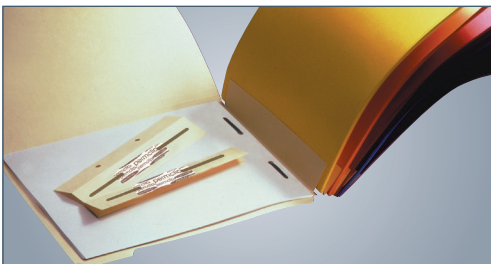

Turn existing file folders into classification folders easily and inexpensively. Section files by date, subject or other criteria that fit your needs.

Slip the punched flap over an existing fastener and close the prongs. Fold flap forward and add filing material to the bonded fastener on top of the manila strip. **earflap™ fasteners** work with any two-prong fastener in all folder positions.

stock no.	description	fasteners/box
56809	earflap fasteners	50

foamclip® fasteners



Self-adhesive **foamclip® fasteners** are a perfect choice for organizing any 2-hole punched papers. These fasteners bond permanently to file folders, pressboard, plastic, wood, glass, even metal. With their superior strength, **foamclip® fasteners** can't be pulled off like other brands! The 2-3/4" center-to-center, 1-1/2" capacity fastener is easy to use; just peel off backing paper and press fastener into place.

stock no.	description	fasteners/box
56807	foamclip fasteners	100

jalemaclip fasteners

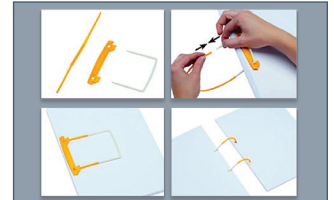

jalemaclip fasteners are 5" capacity fasteners that allow you to access any part of the file without having to remove the file contents. Make notes, copy or review the pages within the file quickly and easily. For use with 2-hole punched documents. Holes are positioned 2-3/4", center-to-center. Sets consist of self-adhesive bases, compressor bars and u-shaped extensions.

stock no.	description	fasteners/box
56804	jalemaclip fasteners	100

u-file-m binder strips

u-file-m binder strips make each folder read like a book. Documents are affixed to a strip of tabs in either ascending or descending order. File by either older information first, or by newer information on top. Instructions included. Permanent adhesive.

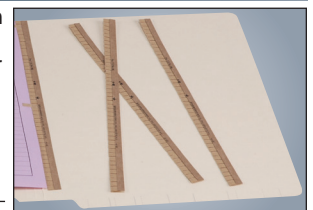

stock no.	description	strips/box
56820	u-file-m binder strip	100

Strip holds up to 22 sheets.

factory installed fasteners

permclip® fasteners are heat-bonded for permanent adhesion to the file folder. **permclip® fasteners** are factory installed in any position to fit your filing needs. Prongs are 2" in length and 2-3/4" center to center. Please specify fastener position from the position guide at the time of order.

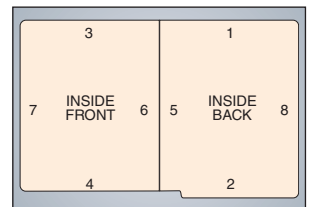

Fastener Position Guide

stock no.	description
56811	one bonded fastener per folder
56812	two bonded fasteners per folder

Also see Page 17
2-Hole
Reinforcing Strips

Any of the above stock fasteners can be factory installed to fit your filing needs.

Choose your fastener position from the position guide above.

laser / inkjet file folder labels

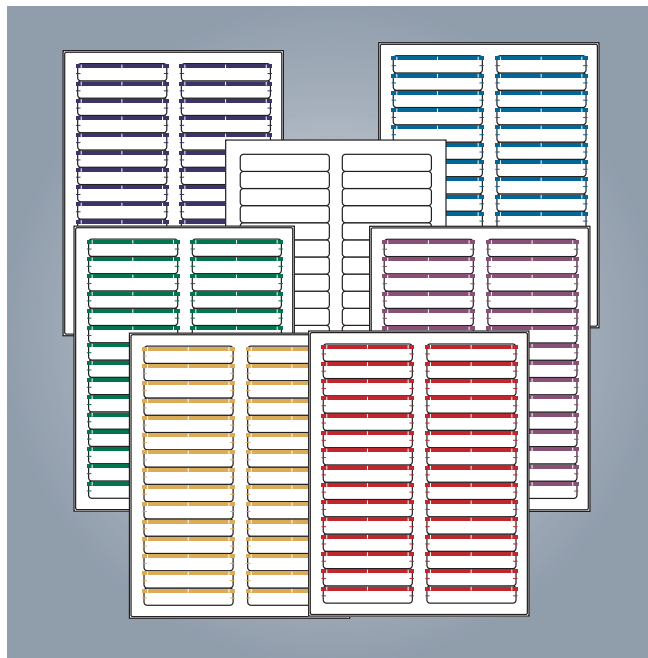

laser / inkjet file folder labels are easy to use with most label software. The paper and adhesive are formulated specifically for use in laser or inkjet printers. 750 labels per package. Labels are 2-up per page. Overall sheet size: 8-1/2" w x 11" h

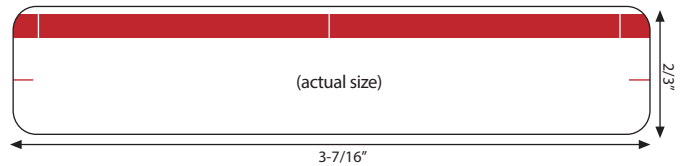

Avery #5366 Laser/Inkjet File Folder Labels compatible series

stock no.	color	labels/sheet	sheets/pkg.
49430	White	30	25
49431	Light Blue	30	25
49432	Red	30	25
49436	Green	30	25
49437	Dark Blue	30	25
49441	Tan	30	25
49443	Purple	30	25

file folder labels

Self-adhesive **file folder labels** attach permanently to file folders, cards, etc. Color coded for easy identification and smudge proof for legibility. Available in convenient sheets, in white and 6 colors ready for writing or typing. Labels are 3-7/16" w x 9/16" h in size. Labels are 1-up per page.



Writable only. This product is not intended for use with printer.

stock no.	color	labels/pkg.
59430	White	248
59431	Light Blue	248
59432	Red	248
59436	Green	248
59437	Dark Blue	248
59441	Tan	248
59443	Purple	248

wrap-around file folder labels

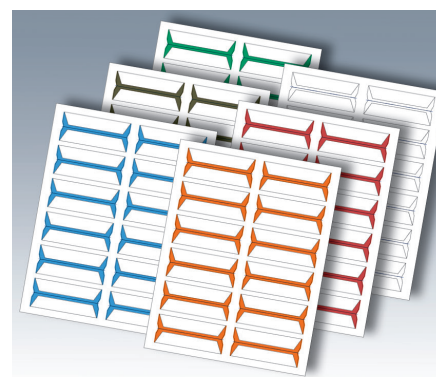

Use Microsoft Word® and any laser/inkjet printer to create **wrap-around file folder labels** for file folders, pockets, jackets, etc. Easy set-up instructions for both drawer and shelf filing applications in each package. 8-1/2" w x 11" h sheets.

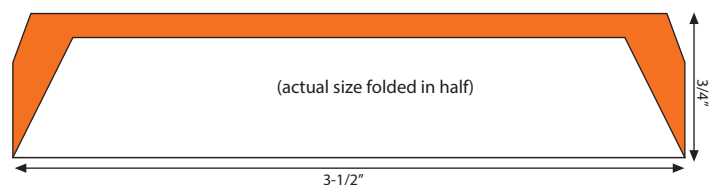

Acme® Abgor File Folder Labels compatible series

stock no.	color	labels/sheet	labels/pkg.
49401	Azure Blue	12	240
49402	Brown	12	240
49403	Green	12	240
49404	Orange	12	240
49405	Red	12	240
49406	White	12	240

name label protectors

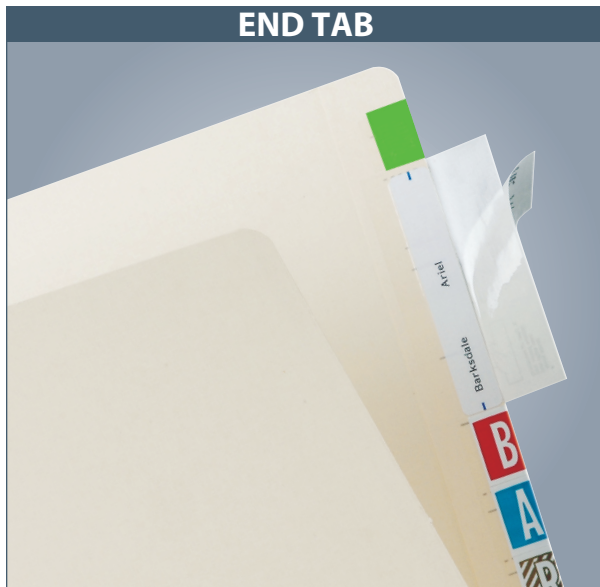

name label protectors eliminate dirty, worn, dog-eared file folders and file folder labels. Clear, wrap-around, self-adhesive protectors keep file folders and labels clean and prevent them from falling off, extending the life of the folder.

name label protectors can also be used "flat" to attach miscellaneous materials to any surface.

stock no.	protectors/ size	pkgs./ pkg.	protectors/ box	roll
58385	3-1/2"w x 2"h	100	5	–
58485	4"w x 2"h	100	5	–
58385B	3-1/2"w x 1-3/4"h	–	500*	–
88385	3-1/2"w x 2"h	–	–	500
88485	4"w x 2"h	–	–	500

*500 single protectors per box



full end tab protectors



end tab protectors are an ideal solution for extending the life of shelf file folders. Clear protectors wrap around folder end tabs, preventing labels from cracking or popping off, and protect against wear and tear.

Self-adhesive, 8" x 2" protectors can be easily applied to all types of end tab file folders to keep them looking neat and clean longer.

stock no.	size	protectors/pkg.
68386	8"h x 2"w	100

spine edge protectors



edge protectors keep heavily used file folders looking good longer by protecting edges from cracking or splitting. The 11" x 2" clear, wrap-around protector is easily applied to the bottom edge of a file folder, where the most wear and tear occurs as the folder is moved in and out of shelf file cabinets.

stock no.	size	protectors/pkg.
68387	11"w x 2"h	100

All of the above products can also be used to reinforce documents and page edges that require hole punching and insertion into binders or folders with fasteners. Simply follow the easy application instructions on the pack of each strip, then punch the document as needed.

lock-it pockets

Durable, clear polyethylene ziplock style secures small documents, including photos, flash drives, CD's, x-rays and much more. Peel off self-adhesive 5 mil poly pocket. Permanently apply to your folders or wherever it is most convenient. Clear front keeps important information at full view without opening the pocket.

stock no.	inside	outside	pockets/box
54470	5"w x 5-1/4"h	5-1/2"w x 6-1/4"h	100
54471	6"w x 9"h	6-1/2"w x 10"h	100

First dimension is the pocket opening



poly & vinyl pockets

Clear see-thru pockets are available in several sizes to fit all your needs. It's easy to add a pocket to your file or binder; simply peel off the protective backing and apply the self-adhesive side to your folder. Pockets are sealed on three sides. Store x-rays, forms, immunization records, flash drives, CD's and more.

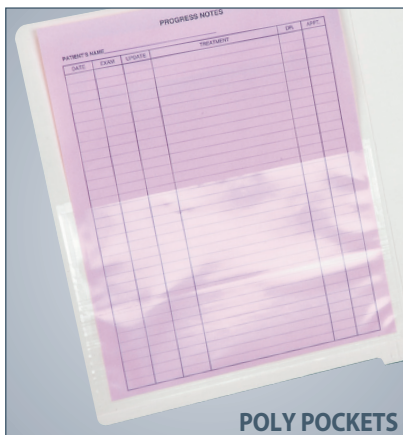

POLY POCKETS

Poly pockets provide easy access to information.

Poly Pockets

stock no.	inside	outside	pockets/box
54495	2-1/2"w x 3-1/4"h	3"w x 3-3/4"h	100
54496	10-1/2"w x 8-1/2"h	11"w x 9"h	100
54497	5"w x 3"h	5-3/4"w x 3-3/4"h	100
54498	6-1/2"w x 4-1/4"h	7"w x 4-3/4"h	100
54499	8-3/4"w x 5-1/2"h	9-1/4"w x 6"h	100

Vinyl Pockets

stock no.	inside	outside	pockets/box
54492	8-3/4"w x 11-1/4"h	9"w x 11-1/2"h	100
54493	5-1/4"w x 3-1/4"h	5-1/2"w x 3-1/2"h	100
54494	8-3/4"w x 5-1/2"h	9"w x 5-3/4"h	100

First dimension is the pocket opening

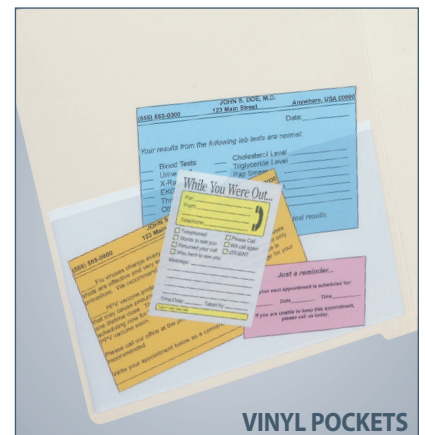

VINYL POCKETS

Vinyl pockets are textured and heavy-duty.

expanding divider pockets

Strong 40 lb. Kraft pocket has a thumbcut opening for easy access. Reinforced binding holes are pre-punched to be used with fastener folder. Letter or legal size application. Pocket has a 1" expansion.

stock no.	description	pockets/box
54460	divider pockets	100



Also see Page 13
Fasteners

2-hole reinforcing strips

Add durability and longevity to your documents with our **2-hole reinforcing strips**. Strips are self-adhesive for easy use. Material is tear resistant and clear so it will not hide printed information.

stock no.	description	strips/box
58392	3-1/2" 2-hole punched	500 strips (bulk)

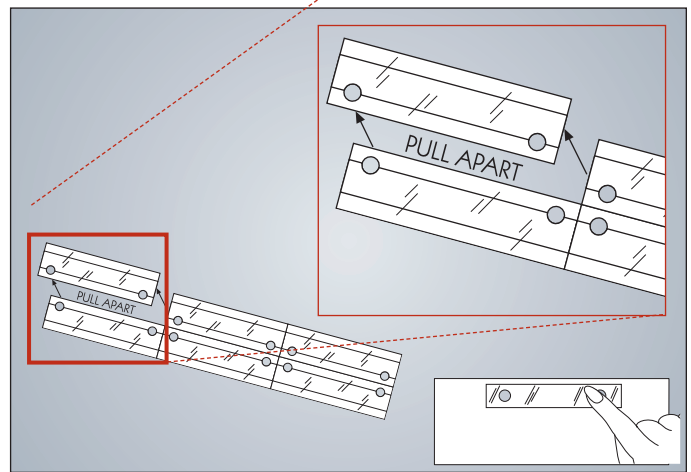

5-hole reinforcing strips

5-hole reinforcing strips are made of tear resistant material, pre-punched and ready to use. Clear strips will not hide printed information. The **5-hole reinforcing strips** can be used in one of three ways:

stock no.	description	strips/pkg.	pkgs./box
58390	11" 5-hole punched 2" overall (1" pulled apart)	20	10

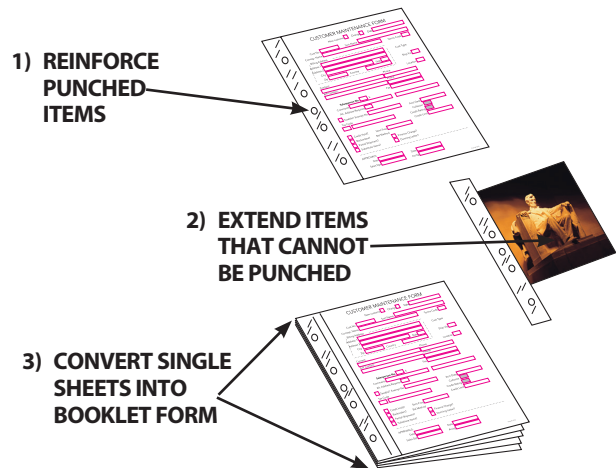

cd saver™ sleeve protectors



Protect compact disks in these smooth, durable polypropylene sleeves in stylish, translucent colors. Disks stay clean and organized, and a tuck-in flap holds CDs more securely than an open pocket. **cd saver sleeve protectors** come with self-adhesive labels for built-in index tabs.

stock no.	description	sleeves/pkg.	pkgs./carton
25100	Assorted	10	12
25101	Clear	25	10

outguides

vinyl outguides are flexible enough for easy handling, yet resist cracking and tearing. Double sided "OUT" tab extends beyond folder for easy access. Clear vinyl pocket holds charge-out slips. Heavy duty outguides feature large tabs, a rigid vinyl back and stress contours on pockets to provide added strength and durability for frequent handling.

Call to inquire about other available colors.

charge-out slips

charge-out slips keep track of removed folder, when used with outguide. 100 sheets/pad.

stock no.	size	pads/box
74559	5"w x 3"h	10

FILE NAME/NUMBER _____
DATE OUT _____ DATE RETURN _____
NAME (PRINT) _____ DEPT. _____
SIGNATURE _____
<small>INSERT THIS CHARGE-OUT FORM INTO THE POCKET ON THE OUTGUIDE AND REPLACE CHARGE-OUT FOLDER WITH OUTGUIDE. NOTE: DUPLICATE CHARGE-OUT FORMS CAN BE USED FOR FOLLOW-UP PURPOSES. IN "FILE NAME/NUMBER" ORDER OR "DATE TO RETURN" ORDER.</small>
<small>TABBIES STOCK NO. 74559</small>

center tab

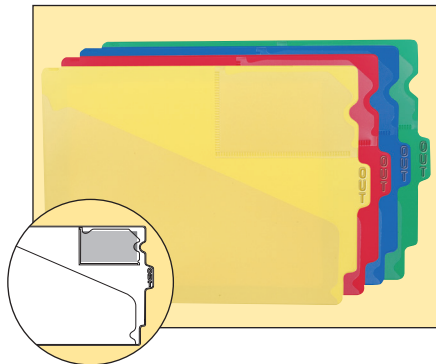

- ◆ "OUT" is embossed on both sides of tab
- ◆ Overall size: 9-1/2"h x 12-7/8"w
- ◆ Body size: 9-1/2"h x 12-3/8"w

stock no.	color	size	guides/pkg.
74500	Red	Letter	10
74501	Blue	Letter	10
74502	Green	Letter	10
74504	Yellow	Letter	10
74520*	Red	Legal	10

*Legal size: Overall size: 9-1/2" x 15-3/4"
Body size: 9-1/2" x 15-1/4"

bottom tab

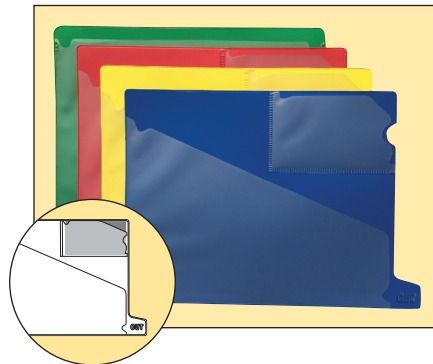

- ◆ "OUT" is embossed on the tab
- ◆ Overall size: 9-1/2"h x 13-1/4"w
- ◆ Body size: 9-1/2"h x 11-7/8"w

stock no.	color	guides/pkg.
74530	Red	10
74531	Blue	10
74532	Green	10
74534	Yellow	10

large tab

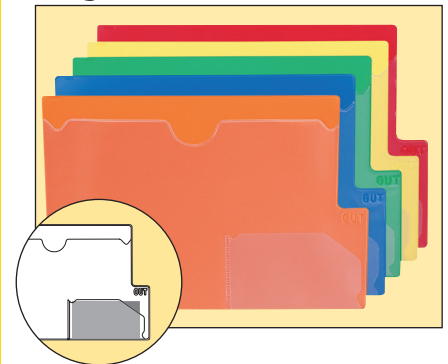

- ◆ "OUT" is embossed on the tab
- ◆ Overall size: 9"h x 13-1/4"w
- ◆ Body size: 9"h x 12"w

stock no.	color	guides/pkg.
74580	Red	10
74581	Blue	10
74583	Orange	10
74584	Yellow	10
74585	Green	10

economical

A cost-efficient choice when a full pocket is not necessary. Easy to read "OUT" is embossed on both sides of the rigid vinyl guides. 3" x 5-1/2" pocket for charge-out forms. Letter size 13"w x 4"h.



stock no.	color	guides/pkg.
74540	Red	10
74541	Blue	10
74542	Green	10
74543	Orange	10
74544	Yellow	10

alphabetical & blank

Quickly locate information filed by name. 24-gauge yellow vinyl guides. Black print on both sides A-W, plus one Mc and XYZ. Letter size 14-1/2"w x 4"h.

Blank guides have clear pockets on both sides and include insert cards.



stock no.	description	guides/box
74590	Alphabetical	25
74591	Blank	25

custom installation solutions

Save time and money... choose any of our stock or custom products to fit your filing needs and let us do the custom installation work.

Tabs/Labels

Pockets

Fasteners

Indexes

Filebacks

u-file-m Strips

Conversion Strips

Dividers

Index Tab Divider Positions

52100

53520/54520

53017/58017

14500

40200

53018/58018

Fastener Position Guide

Right End Tab Folder

Top Tab Folder

CALL FOR QUOTE

custom labels

TABBIES has been printing and converting high quality labels and films for packaging and commercial industrial products since 1985. We stock a wide variety of materials, dies and adhesives. We provide paper and film solutions that help you create compelling graphics that project a strong presence and increase brand recognition.



CAUTION/ALERT LABELS:

**BIOHAZARD
BIPELIGRO**

ALLERGY ALERT

**SHARPS
DISPOSAL
ONLY**

**QUARANTINE
AREA
RESTRICTED
ACCESS**

COLOR CODE LABELS:



PROMOTIONAL/MARKETING LABELS

ICE MEDICAL ALERT CARD

ALERTS:

- ADVANCE DIRECTIVE
- ASTHMA
- DIABETIC
- HEARING IMPAIRED
- HEART CONDITION
- IMPLANTS
- NO EPINEPHRINE ON ANTI-COAGULANTS
- PACEMAKER
- PREMENSTRUE
- STROKE PATIENT
- OTHER

ALLERGIC TO:

- PENICILLIN
- COCAINE
- SULFA

NAME: _____ TEL: _____

DR. NAME: _____ TEL: _____

PHARMACY: _____ TEL: _____

MEDICAL WASTE STICKERS

We have supplied medical waste companies with regulatory labels since 1985 and we have the materials and adhesives needed to meet the medical waste industry's unique requirements.

OUR LABELS ARE 100% CUSTOMIZABLE AND WE OFFER LABELS THAT ARE:

- Durable - Will withstand bleach and enzyme wash cycles
- Removable - Will blow off without residue during the wash cycles

Whether you are a commercial manufacturer or home user, save money by purchasing cover up labels for out of date hot stamps. H.H.H. Incorporated - Stick with Us!

BIOHAZARD AUTOCLAVE BEFORE DISPOSAL

DATE AUTOCLAVED: _____

Medicine Coupons.net

DRUG DISCOUNT CARD

Member ID: _____

Member Support: 800-885-7500

Medicine Coupons.net

Pharmacy: _____

Member Support: 877-877-2828

REBATE/INSTRUCTION LABELS:

MANUFACTURER'S COUPON

SAVE 10% NOW

INSTANT REFUND

SAVE NOW!

Instant rebates, build awareness and promote your products through 360's (instant redeemable coupons).

- Single-use, limited printing
- Multiple messaging in a minimum size
- Paper and Film substrates

MED CARD

DATE	DOSE	FREQUENCY

I ALSO TAKE:

- OVER THE COUNTER
- HERBALS
- EYE DROPS
- SUPPLEMENTS
- VITAMINS
- INHALERS

NAME: _____ TEL: _____

DR. NAME: _____ TEL: _____

PHARMACY: _____ TEL: _____

BLANK LABELS:

INTEGRATED LABEL FORM

THIS SECTION USED FOR DIRECTIONS AND WARNINGS

MARKET APPLICATIONS

Grocery

- Recipes
- Cooking instructions
- Warnings
- International directions
- Multi-lingual copy

Manufacturing

- Extended product-line awareness
- Cross-selling
- Multi-lingual instructions

Food & Beverage Distribution

- Promotional
- Product launches
- Cross-sell other products
- Clearance
- Scratch-&-Sniff
- Product identification & Promotional receipts

Health & Beauty

- Immediate rebates & incentives
- Product identification & Consumer rebates

THERMAL TRANSFER LABELS:





label refill packages

Color code filing labels on demand

30010 End Tab File Folder Name Labels

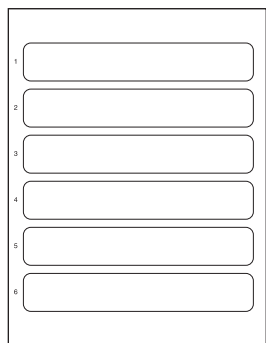

stock no.	description	label size	labels/pkg.
30010	end tab file folder name labels	1-1/4"W X 7-1/2"H	300
30011	top tab file folder name labels	3-1/2"W X 1"H	700

Up to six 1/2" alpha or numeric characters, with two line name label option, year code and 1/2" solid color designator options

(6 labels per sheet, 50 sheets per pack)
(for use with COL'R'TAB® II label software)

30011 Top Tab File Folder Name Labels

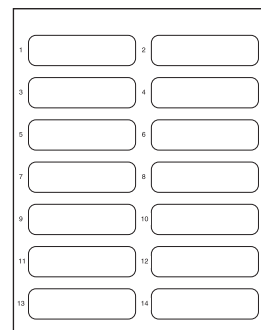

Standard 1/3 cut top tab name label with color stripe option

(14 labels per sheet, 50 sheets per pack)
(for use with COL'R'TAB® II label software)

labels-u-create



Create bright, eye-catching communication labels in seconds, using your PC and laser printer with **labels-u-create** to make custom labels for any application. Permanent labels can be applied to folders, documents, drawers, even shelving. Make an entire sheet of the same label or just a few at a time. Easy set-up instructions inside. Works with Microsoft Word®. No additional software is needed. 10 (8-1/2"x11") sheets per package. Available in 3 colors plus white.

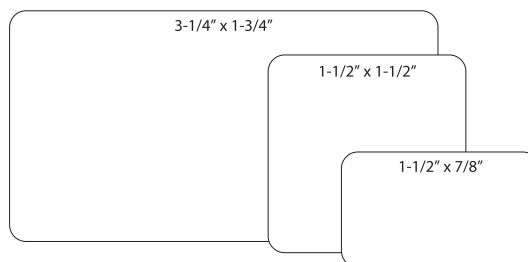

stock no.	label size	color	labels/sheet	labels/pkg.
40100	1-1/2" X 7/8"	White	32	320
40101	1-1/2" X 7/8"	Fl. Red	32	320
40102	1-1/2" X 7/8"	Fl. Green	32	320
40103	1-1/2" X 7/8"	Fl. Yellow	32	320
40120	1-1/2" X 1-1/2"	White	20	200
40121	1-1/2" X 1-1/2"	Fl. Red	20	200



stock no.	label size	color	labels/sheet	labels/pkg.
40122	1-1/2" X 1-1/2"	Fl. Green	20	200
40123	1-1/2" X 1-1/2"	Fl. Yellow	20	200
40140	3-1/4" X 1-3/4"	White	10	100
40141	3-1/4" X 1-3/4"	Fl. Red	10	100
40142	3-1/4" X 1-3/4"	Fl. Green	10	100
40143	3-1/4" X 1-3/4"	Fl. Yellow	10	100

blank strip labels

Let **TABBIES** quote you on manufacturing any 8-1/2" x 11" strip label sheets. We can match any computer generated blank label configuration for use with any color coded label on demand system in the marketplace today. Call **TABBIES** Customer Service for further information and a quote.

laser/inkjet label sheets

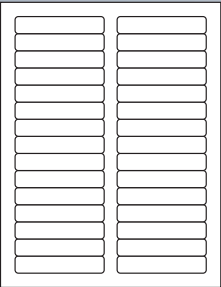
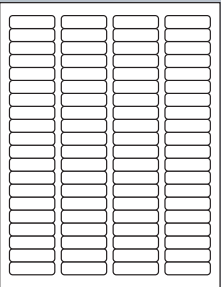
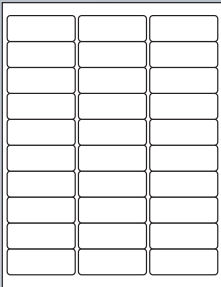
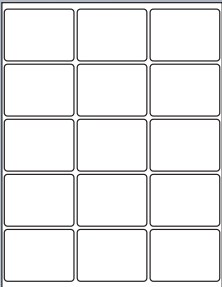
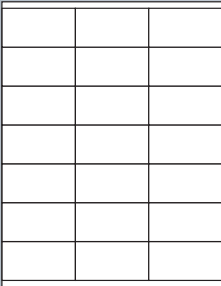
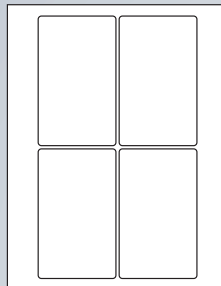
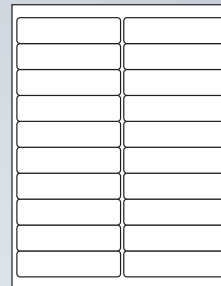
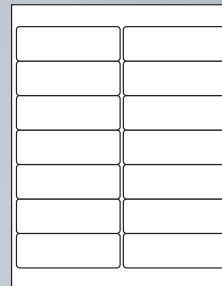
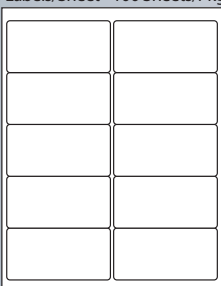
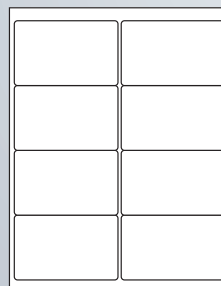
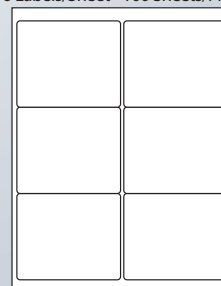
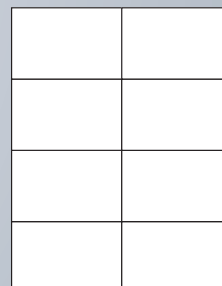
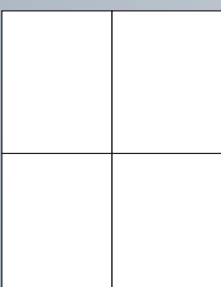
Multi-use **laser/inkjet label sheets** are useful for mailings, announcements, getting organized, tracking or recalling documents and more. Permanent labels are easy to apply for convenient, personalized labels anytime. Sheets are shrink-wrapped in packages and are fully compatible with both laser and inkjet printers. Labels feed automatically from paper tray and are centered on sheets so they can be fed using either the top or bottom as the lead edge. *See your printer manual for additional feeding instructions.*

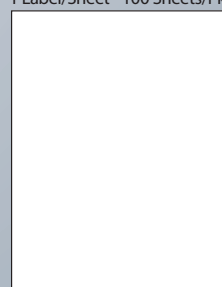
<p>Stock No. 49430 Matches Avery® No. 5366 3-7/16" x 2/3" 30 Labels/Sheet - 25 Sheets/Pkg</p> 	<p>Stock No. 40150 Matches Avery® No. 5167 1-3/4" x 1/2" 80 Labels/Sheet - 100 Sheets/Pkg</p> 	<p>Stock No. 40151 Matches Avery® No. 5160 2-5/8" x 1" 30 Labels/Sheet - 100 Sheets/Pkg</p> 	<p>Stock No. 40152 Matches Avery® No. 6490 2-11/16" x 2" 15 Labels/Sheet - 100 Sheets/Pkg</p> 
<p>Stock No. 40153 2-13/16" x 1-1/2" 21 Labels/Sheet - 100 Sheets/Pkg</p> 	<p>Stock No. 40154 3" x 5" 4 Labels/Sheet - 100 Sheets/Pkg</p> 	<p>Stock No. 40156 Matches Avery® No. 5161 4" x 1" 20 Labels/Sheet - 100 Sheets/Pkg</p> 	<p>Stock No. 40157 Matches Avery® No. 5162 4" x 1-1/3" 14 Labels/Sheet - 100 Sheets/Pkg</p> 
<p>Stock No. 40158 Matches Avery® No. 5163 4" x 2" 10 Labels/Sheet - 100 Sheets/Pkg</p> 	<p>Stock No. 40159 4" x 2-1/2" 8 Labels/Sheet - 100 Sheets/Pkg</p> 	<p>Stock No. 40160 Matches Avery® No. 5164 4" x 3-1/3" 6 Labels/Sheet - 100 Sheets/Pkg</p> 	<p>Stock No. 40161 4-1/4" x 2-3/4" 8 Labels/Sheet - 100 Sheets/Pkg</p> 
<p>Stock No. 40162 4-1/4" x 5-1/2" 4 Labels/Sheet - 100 Sheets/Pkg</p> 	<p>Stock No. 40163 8-1/2" x 3-1/2" 3 Labels/Sheet - 100 Sheets/Pkg</p> 	<p>Stock No. 40164 8-1/2" x 5-1/2" 2 Labels/Sheet - 100 Sheets/Pkg</p> 	<p>Stock No. 40165 Matches Avery® No. 5165 8-1/2" x 11" 1 Label/Sheet - 100 Sheets/Pkg</p> 

communication labels

remind'r' labels

MEDICAL ALERT

40524

ALLERGIC TO:

40525

DIABETIC

40528

CONFIDENTIAL

40531

stock no.	description	color	size	labels/roll
40524	Medical Alert	Fl. Red	1-1/2" x 3/4"	250/Roll
40525	Allergic To:	Fl. Red	1-1/2" x 3/4"	250/Roll
40528	Diabetic	Fl. Red	1-1/2" x 3/4"	250/Roll
40531	Confidential Label	Fl. Red	1-1/2" x 3/4"	250/Roll

attention/alert labels

NAME ALERT

Birthdate _____

MAP1180

NAME ALERT

Two patients with same name

NAME ALERT

MAP6470

NAME ALERT

MAP345

stock no.	description	color	size	labels/roll
MAP1180	Name Alert Birthdate	Fl. Red	1-1/2" x 7/8"	250/Roll
MAP3410	Name Alert D.O.B.	Fl. Chartreuse	3-1/4" x 1-3/4"	250/Roll
MAP345	Name Alert	Fl. Chartreuse	1-1/4" x 5/16"	500/Roll
MAP3500	Advanced Directive	Fl. Orange	1-1/4" x 5/16"	500/Roll
MAP5180	Medical Alert	Fl. Red	3-1/4" x 1-3/4"	250/Roll
MAP6470	Name Alert Same Name	Fl. Chartreuse	3"x1"	250/Roll

NAME ALERT

D.O.B. _____

MAP3410

ADVANCE DIRECTIVE

Living Will _____

Health Care Proxy _____

Durable Power of Attorney for Health Care _____

Other _____

MAP3500

MEDICAL ALERT

MAP5180

billing/collection labels

SELF PAY

MAP1320

FINAL NOTICE

If we do not hear from you within 10 days, this account will be turned over to our collection agency.

MAP4790

ATTENTION OFFICE STAFF:

CO-PAY

\$ _____

Collect at time of visit

MAP40566

stock no.	description	color	size	labels/roll
MAP1350	Past Due Remit Today	Fl. Red	1-1/2" x 7/8"	250/Roll
40566	Attention Co-Pay Label	Fl. Red	3" x 1"	500/Roll
MAP4790	Final Notice Collection	Fl. Red	3-1/4" x 1-3/4"	250/Roll
MAP4220	Reminder Account Overdue	Fl. Green	1-1/2" x 7/8"	250/Roll
MAP1320	Self Pay	Fl. Green	1-1/2" x 7/8"	250/Roll
MAP4500	Please Note Acct Past Due	Fl. Chartreuse	1-1/2" x 7/8"	250/Roll

PAST DUE

Please remit TODAY!

MAP1350

Just a friendly reminder that your account is overdue. Won't you please mail your remittance?

MAP4220

PLEASE NOTE

This account is PAST DUE. Your prompt attention is courteously requested.

MAP4500

chart labels

CHART INACTIVATED

Moved/Unable to Contact
 Transferred to Another Doctor
 Non-Payment
 Missed Appointments
 No Response To Scheduling Attempts
 Patient Deceased
 Other _____

MAP1540

MINOR

MAP3550

DIABETIC

MAP3530

stock no.	description	color	size	labels/roll
MAP1540	Chart Inactivated Reasons	White	3-1/4" x 1-3/4"	250/Roll
MAP2220	Primary Care Physician	Fl. Chartreuse	3" x 1"	250/Roll
MAP343	STAT	Fl. Red	1-1/4" x 5/16"	500/Roll
MAP3530	Diabetic	Fl. Pink	1-1/2" x 7/8"	250/Roll
MAP3550	Minor	Fl. Green	1-1/2" x 7/8"	250/Roll

STAT

MAP343

PRIMARY CARE PHYSICIAN:

Dr. _____

MAP2220

communication labels

allergy labels

stock no.	description	color	size	labels/roll
40560	Allergies	Fl. Red	2" x 2"	500/Roll
40561	Allergic: Label	White/Red	5-1/2" x 1"	175/Roll
40562	Allergic To: Wrap-Around	White/Red	3" x 1"	500/Roll
MAP1000	Allergic To:	White/Red	1-1/2" x 7/8"	250/Roll
MAP1510	No Known Allergies	Lt Blue	1-1/2" x 7/8"	250/Roll
MAP1630	Allergies	Fl. Red	3-1/4" x 1-3/4"	250/Roll
MAP167	Allergic	White/Red	6-1/2" x 1"	100/Roll
MAP1730	Allergies/Drug Reactions	Fl. Pink	3-1/4" x 1-3/4"	250/Roll
MAP3220	Allergies 2"x2"	Fl. Red	2" x 2"	250/Roll
MAP3230	Allergies/Drug Reactions	Fl. Red	3-1/4" x 1-3/4"	250/Roll
MAP3250	Allergies Listing	Fl. Red	3-1/4" x 1-3/4"	250/Roll
MAP327	Allergies/Drug Reactions	Fl. Red	4" x 2-1/2"	100/Roll
MAP3300	Allergy - Allergic To	White/Red	3-1/4" x 1-3/4"	250/Roll
MAP488	Allergic Penicillin Codeine Sulfa	Fl. Red	4" x 2-1/2"	100/Roll
MAP4900	Allergic Penicillin Codeine Sulfa	Fl. Red	3-1/4" x 1-3/4"	250/Roll
MAP6440	Allergic To: Allergy	White/Red	3-1/4" x 1-3/4"	250/Roll
UL927	Allergic	White/Red	5-1/2" x 1"	240/Roll



40562



40560



40561/UL927



MAP1000

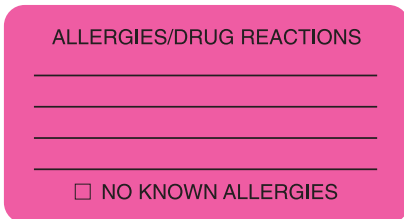

MAP1730



MAP3220



MAP1630



MAP1510

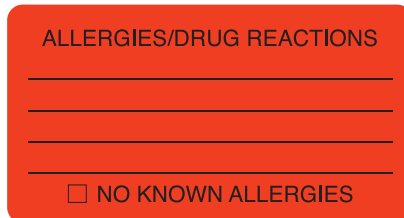

MAP3230



MAP167

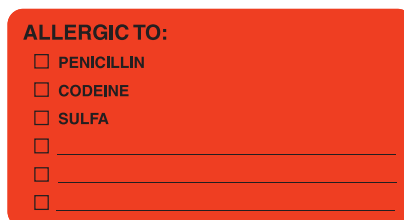

MAP4900

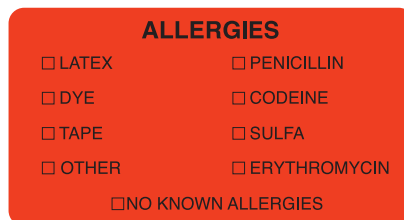

MAP3250

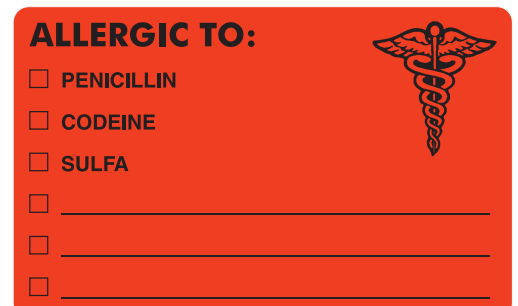

MAP488



MAP6440



MAP3300



MAP327

cont'd...

communication labels

allergy labels (cont'd)



MAP496



UL808

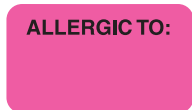

MAP3350

ALLERGIES



UL926



MAP3390



UL702

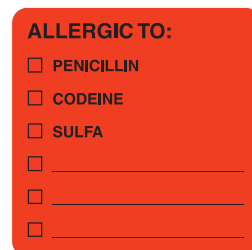

MAP4890

stock no.	description	color	size	labels/roll
MAP496	Allergic To	Fl. Orange	2-1/2" x 3/4"	300/Roll
MAP3350	Allergic To:	Fl. Pink	1-1/2" x 7/8"	250/Roll
MAP3390	Allergic To	Fl. Red	1-1/2" x 7/8"	250/Roll
MAP4890	Allergic To Penicillin Codeine Sulfa	Fl. Red	2" x 2"	250/Roll
UL702	Allergic To	White/Red	3" x 1-1/8"	320/Roll
UL808	Allergic To	Fl. Red	2-1/4" x 7/8"	420/Roll
UL926	Allergies	Fl. Red	2-1/2" x 2-1/2"	390/Roll

hipaa labels



40570



40571

stock no.	description	color	size	labels/roll
40570	Confidential Authorized Personnel Label	Red	2" x 2"	500/Roll
40571	Patient Record Confidential Label	Green	2" x 2"	500/Roll
40572	Confidential Authorized Personnel Label	Red	6-1/2" x 1"	100/Roll
40574	Confidential Authorized Personnel Label	Red	4" x 2-1/2"	100/Roll
MAP7130	HIPAA Requirements Privacy	Red	4" x 2"	250/Roll
MAP7190	HIPAA	Fl. Red	1-1/2" x 7/8"	250/Roll



40574



40572



MAP7190

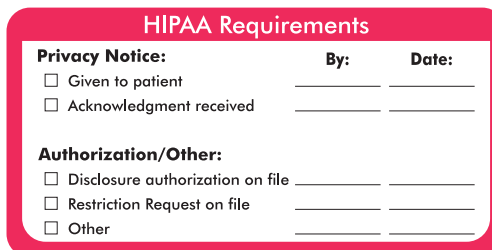

MAP7130

communication labels

insurance labels



MAP1110



MAP1160

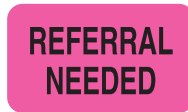

MAP1170



MAP1310



MAP1570

stock no.	description	color	size	labels/roll
MAP1110	Insurance Provider	White/Red	1-1/2" x 7/8"	250/Roll
MAP1160	Medicare	Fl. Orange	1-1/2" x 7/8"	250/Roll
MAP1170	Referral Needed	Fl. Pink	1-1/2" x 7/8"	250/Roll
MAP1310	Attention Staff Co-Pay	Fl. Red	1-1/2" x 7/8"	250/Roll
MAP1570	Insurance	Fl. Red	3-1/4" x 1-3/4"	250/Roll
MAP2830	Insurance	Fl. Pink	3-1/4" x 1-3/4"	250/Roll
MAP2940	Insurance Listing	Fl. Chartreuse	3-1/4" x 1-3/4"	250/Roll
MAP2950	Insurance__	Fl. Orange	3-1/4" x 1-3/4"	250/Roll
MAP3080	Medicare	Fl. Orange	3" x 1"	250/Roll
MAP3090	Medicaid	Fl. Pink	3" x 1"	250/Roll
MAP6420	Insurance	Fl. Pink	3" x 1"	250/Roll
UL007	Insurance	Fl. Chartreuse	1-5/8" x 7/8"	500/Roll



MAP2830

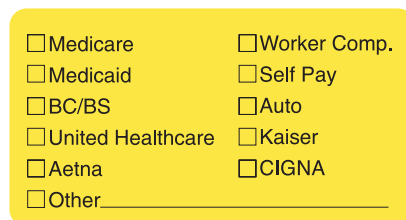

MAP2940

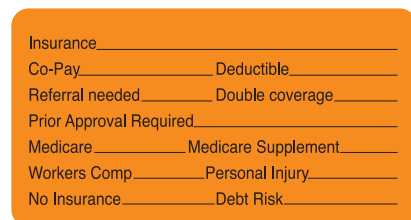

MAP2950



MAP3080



MAP3090



MAP6420



UL007

insurance carrier collection labels



MAP1480

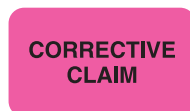

MAP1460

stock no.	description	color	size	labels/roll
MAP1480	Primary EOB Attached	Fl. Green	1-1/2" x 7/8"	250/Roll
MAP1460	Corrective Claim	Fl. Pink	1-1/2" x 7/8"	250/Roll

patient responsibility labels

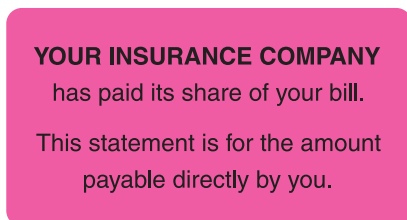

MAP4200

stock no.	description	color	size	labels/roll
MAP4200	Insurance Paid Its Share	Fl. Pink	3-1/4" x 1-3/4"	250/Roll
UL1423	Your Insurance Paid	Fl. Red	3" x 7/8"	320/Roll
UL520	Hate To Keep Hounding	Fl. Pink	2-1/4" x 7/8"	420/Roll

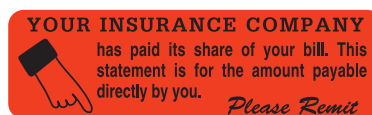

UL1423



UL520

color code filing made easy

Color coding is the assignment of color to a number, letter or particular item that shows meaning. In filing, we assign a color for each number 0 through 9, and a color for each letter A through Z, to aid in filing and retrieval of all types of hard copy files. By putting these colors (letters, numbers and designators) in a particular position on a file folder, file pocket, etc., a color/block pattern is formed. When these patterns of color are broken, a misfile has occurred. In retrieving a file, color recognition reduces look-up time. It also saves presorting time and reduces filing time. In fact, color coded filing can reduce filing and retrieval time by up to 50%. Approximately 75% of every dollar spent in filing areas is people time; therefore, color coding can save as much or more than 33% of the money that is now spent on your present non-color coded files. Misfiles are virtually non-existent in color coded files because of the ease of spotting a file when it is out of order. Memorization of colors is not necessary; the color works as a flag which identifies position or meaning in a file sequence. A good color code system can work for your files, and in most cases pays for itself in less than a year due to the time saved in filing and retrieval without misfiles. Since most files are filed in one of the demonstrated examples, you can easily adapt your file situation to color coding.

alphabetical filing

alphabetical color coded name files are easy to maintain without requiring a cross reference file. Color coding alphabetical breakdowns of initials with color can direct you to the proper file area and help eliminate misfiles, which are most common in non-color coded alphabetical files. Filing of common names is accomplished by coding the first two letters of the last name; for example, James C. Bayer would be coded "BA". In larger alphabetical files, the additional coding of the first name initial will further break up the large name groupings in the file. Using "J" for James, we now can go immediately to the "BA" section and then to the "J" section in the "BA" group to retrieve or refile. When filing corporate or company names, it is suggested to use the first two or three letters of the first full proper name; for example, "Ajax Tool Works" would be coded "AJA".

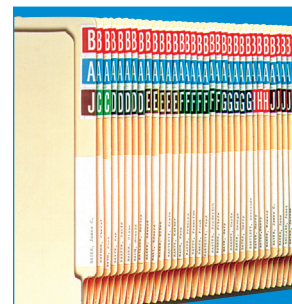

alpha-numeric filing

alpha-numeric filing is simply the filing of letters and numbers in a format that suits the file situation. Many times, files have alphabetical indicators which have a particular meaning in a numeric file, or vice versa. When filing alpha-numeric files, a decision must be made as to whether the number or the letter is more important for locating or segregating the file, since the file can be set up either way. An example of alpha-numeric filing (at left) shows a construction company using the alpha prefix of the state in which the construction site is located. In the illustration, IL (postal abbreviation) is for the state of Illinois, job number 123. Job number 124 has the indicator AZ, showing that the construction site is in Arizona, which is a misfile. The files are kept in alphabetical order by state, then in numerical order by job numbers which are assigned in sequence as construction sites become available. Alpha-numeric files need not be complicated; numbers or letters used in an alpha-numeric file can give added dimension for presorting, filing and retrieval.

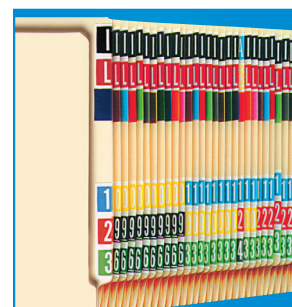

Note that AZ 124 is a misfile.

straight numeric filing

straight numeric filing is the filing of numbered documents in a numerical sequence order starting from the first number and proceeding to the highest numbered file (last or most recent). Color coding a straight numeric file is somewhat dependent upon the total number of files. In the example, we have color coded all five digits. In straight numeric filing, time-saving and cost-saving advantages can be gained by coding the last two digits (tens and units) of the number with one double-digit color block. (Note - the units and tens digit must be color coded separately if you are considering converting to terminal digit filing at a later date.) The major advantages of straight numeric filing are (1) no training of file personnel, since most people know how to find files if they are numbered from the lowest through the highest number in the files, (2) ease of retiring old files. In most cases of straight numeric files, the oldest files are the ones with the lowest numbers.

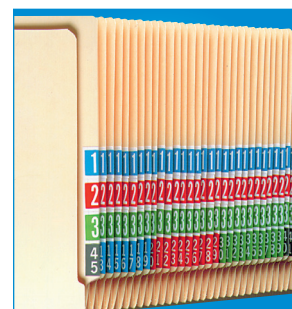

terminal digit filing

terminal digit filing is the filing of all files ending in the same last two digits in one section, forming 100 distinct file groups (00 through 99) in any given file number situation. The use of terminal digit filing is usually seen in large file areas: hospitals, insurance companies, government, banking, etc. It speeds up retrieval time and reduces refile time by segregating files into groups of 00 through 99 (example #12345) terminal digits (45), middle digits (23 within the 45 section) and tertiary digits (01 within the 23 section). For example, file 12345 (01-23-45) would be filed in the 45 section next to file 2345 (00-23-45). File 12346 (01-23-46) which would normally be put next to 12345, would be filed in the 46 section (then in the 23 section, then 01 within 23 section). Note the misfile - two files in the 45 section between subsections 21 and 22 that should be in the middle digit section 24 (file numbers larger than six digits can also be filed in terminal digit order). The major advantage of terminal digit filing is that the file grows equally in 100 places and reduces itself in 100 places with the retirement of older files, forming an equal growth pattern in the file.

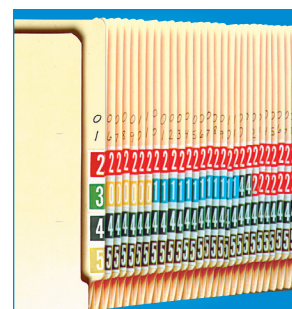

original col'r'tab® color code labels

Original Col'RTab® color code labels provide the best value of any label system in the industry. The unique hinged construction allows for consistent and quick application to file folders, pockets, or even pressboard folders. The clear, outside skirt offsets any tendency for the labels to "hook" onto one another when pulled from the shelf. Made with heavy duty paper and fade-resistant inks. Do not settle for inexpensive color matches – realize the value and savings by using only original Col'RTab products!

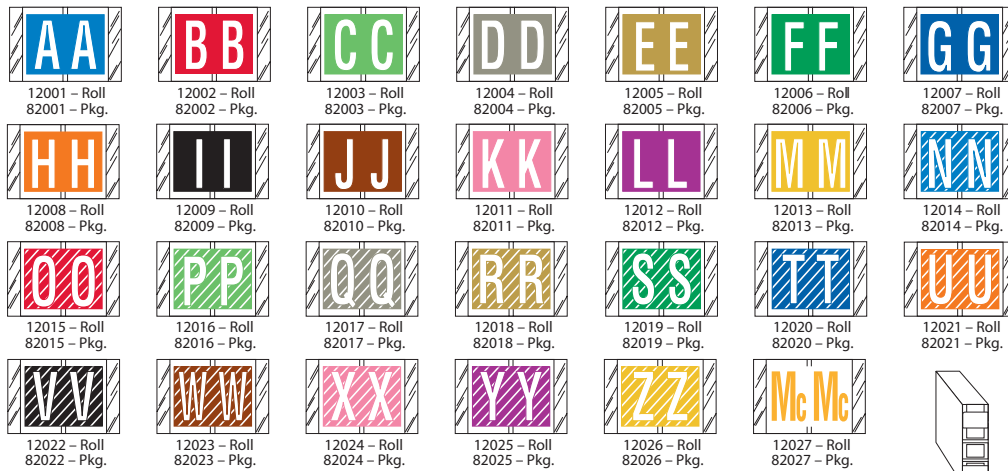

12000 / 82000 series
Original Col'RTab®

1"H x 1-1/2"W – Label size

ROLL / 500 labels per roll
Roll Unit – 42000 (28 rolls)

PACK / 100 labels per pkg.
10 labels per strip
Sheet size: 10" x 1-1/2"

Desktop Kit – 32000 (3,200 labels)

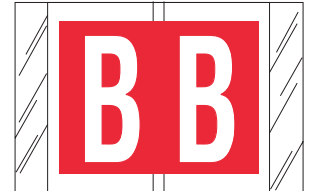

Dispenser Container only – 12000
(Holds 30 Rolls)

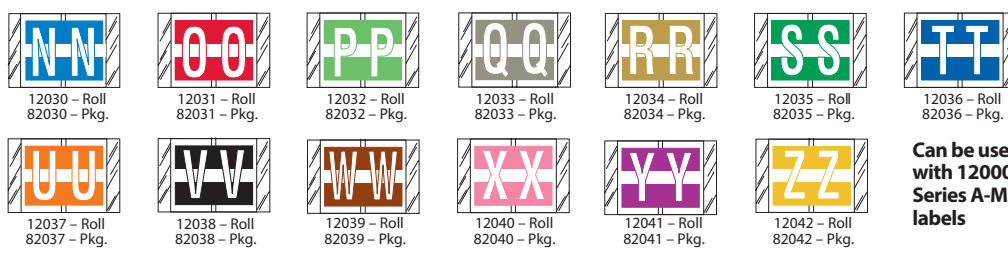

12030 / 82030 series
Original Col'RTab®

1"H x 1-1/2"W – Label size

ROLL / 500 labels per roll
Roll Unit – 42030 (28 rolls)

PACK / 100 labels per pkg.
10 labels per strip
Sheet size: 10" x 1-1/2"

Desktop Kit – 32030 (3,200 labels)

Can be used
with 12000
Series A-M
labels

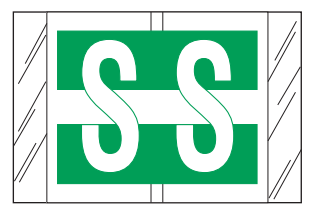

Dispenser Container only – 12030
(Holds 30 Rolls)

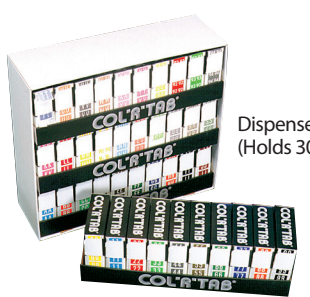

Dispenser Container only – 12000
(Holds 30 Rolls)

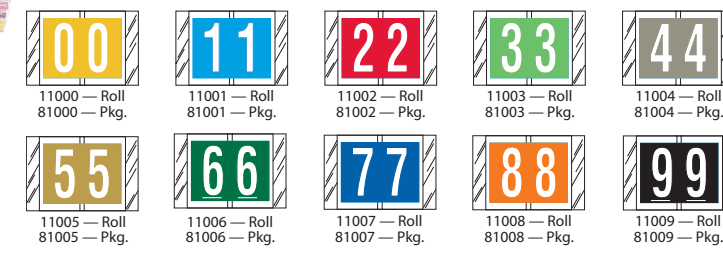

11000 / 81000 series
Original Col'RTab®

1"H x 1-1/2"W – Label size

ROLL / 500 labels per roll
Roll Unit – 41000 (10 rolls)

PACK / 100 labels per pkg.
10 labels per strip
Sheet size: 10" x 1-1/2"

Desktop Kit – 31000 (4,000 labels)

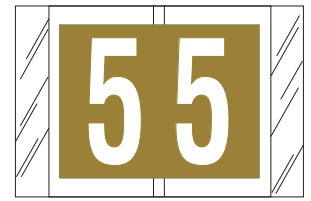

Dispenser Container only – 11015
(Holds 10 Rolls)

original col'r'tab® color code labels

12100 / 82100 series

Original Col'R'Tab®

1-1/2"H x 1-1/2"W – Label size

ROLL / 500 labels per roll

Roll Unit – 42100 (28 rolls)

PACK / 100 labels per pkg.

8 labels per strip

Sheet size: 12" x 1-1/2"

Desktop Kit – 32100 (3,200 labels)

Dispenser Container only – 12000

(Holds 30 Rolls)

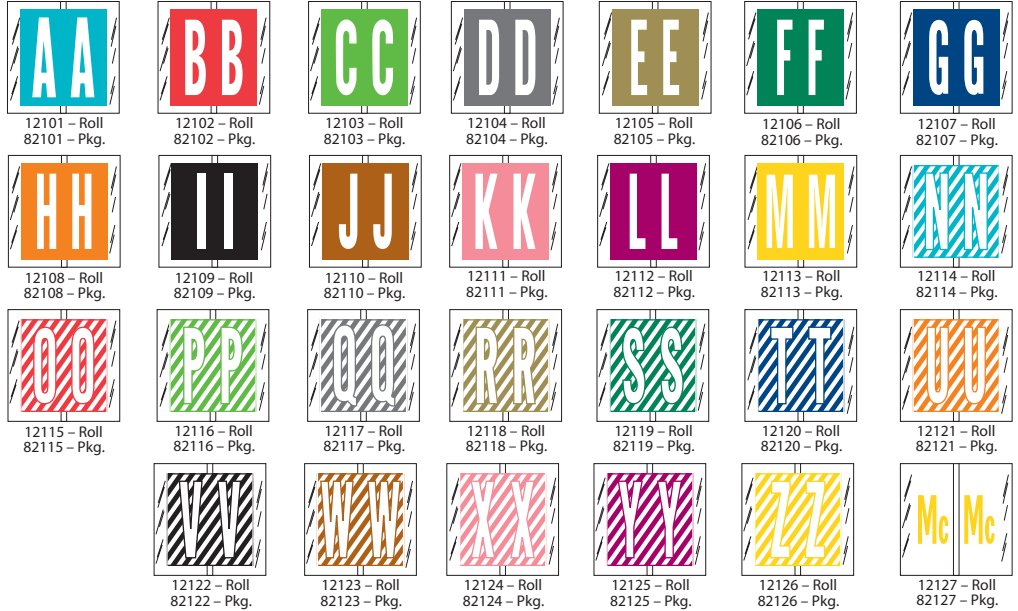
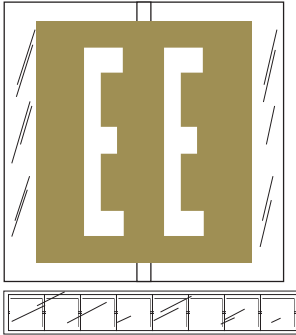
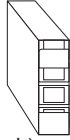

11500 / 81500 series

Original Col'R'Tab®

1-1/2"H x 1-1/2"W – Label size

ROLL / 500 labels per roll

PACK / 100 labels per pkg.

8 labels per strip

Sheet size: 12" x 1-1/2"

Dispenser Container only – 11015

(Holds 10 Rolls)

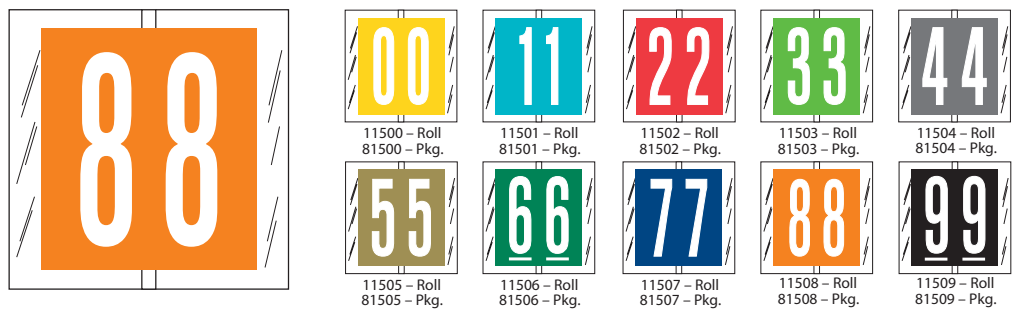
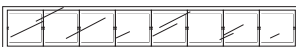
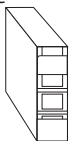

82050 series

Original Col'R'Tab®

1-1/2"H x 1"W (Top Tab) – Label size

PACK / 100 labels per pkg.

10 labels per strip

Sheet size: 10" x 1-1/2"

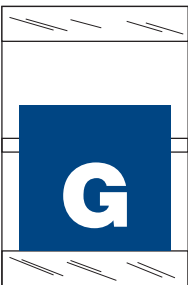

11050 series

Original Col'R'Tab®

1-1/2"H x 1"W (Top Tab) – Label size

ROLL / 500 labels per roll

Dispenser Container only – 11015
(Holds 10 Rolls)



original col'r'tab® color code labels

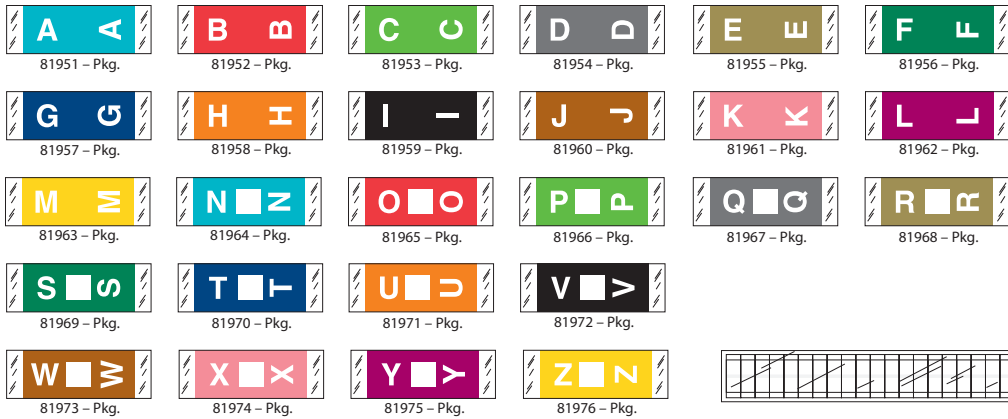

81950 series
Original Col'R'Tab®
1/2"H x 1-1/2"W – Label size
PACK / 100 labels per pkg.
20 labels per strip
Sheet size: 10" x 1-1/2"
Desktop Kit – 31950 (3,100 labels)

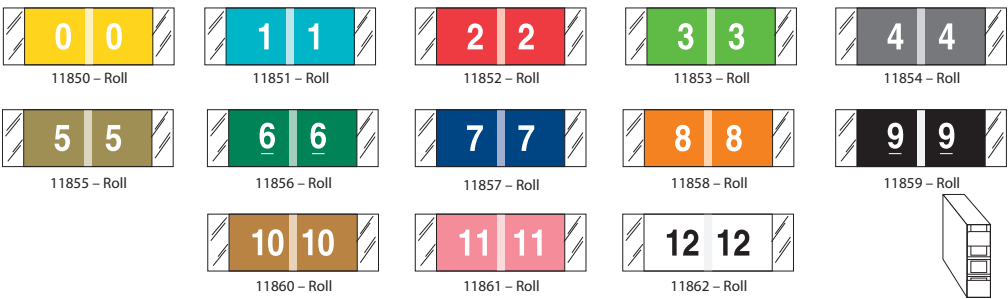
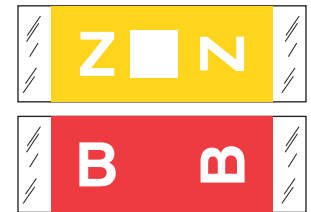

11850 series
Original Col'R'Tab®
1/2"H x 1-1/2"W – Label size
ROLL / 500 labels per roll

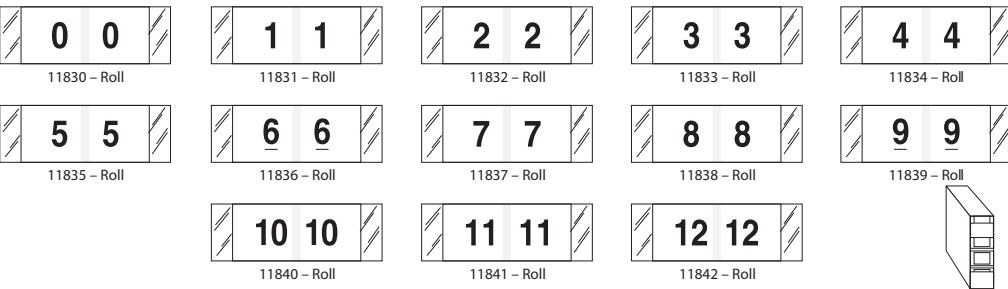

11830 series
Original Col'R'Tab®
1/2"H x 1-1/2"W – Label size
ROLL / 500 labels per roll

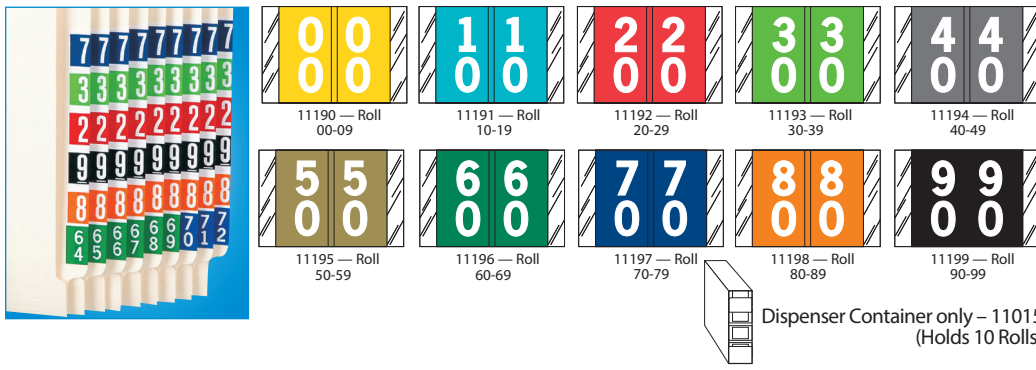

11200 series
Original Col'R'Tab®
1"H x 1-1/2"W – Label size
ROLL / 500 labels per roll
Roll Unit – 11200 (10 rolls)

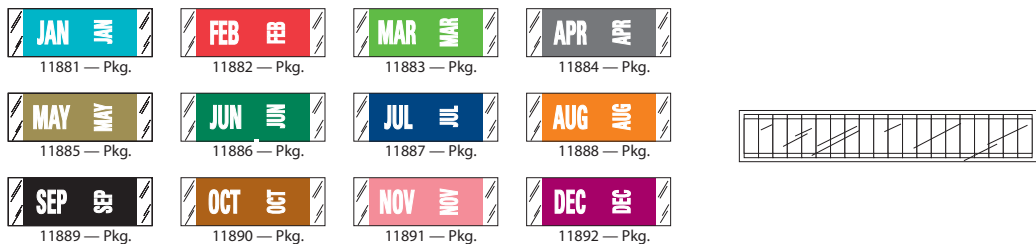
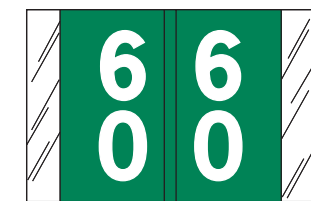

11880 series
Original Col'R'Tab®
1/2"H x 1-1/2"W – Label size
PACK / 100 labels per pkg.
20 labels per strip
Sheet size: 10" x 1-1/2"



original col'r'tab® color code labels

14560 Digi-Kolor™ series

Original Col'R'Tab®

1"H x 1-1/2"W – Label size

ROLL / 500 labels per roll

Original Col'R'Tab® construction

Dispenser Container only – 11015
(Holds 10 Rolls)



14560 – Roll



14561 – Roll



14562 – Roll



14563 – Roll



14564 – Roll



14565 – Roll



14566 – Roll



14567 – Roll



14568 – Roll



14569 – Roll

compatible color code labels

91720 / 61720 series

Jeter® 0200 compatible series

15/16"H x 1-5/8"W – Label size

ROLL / 500 labels per roll

Dispenser Container only – 90150
(Holds 28 Rolls)

RINGBOOK / 240 labels per pkg.
10 labels per sheet – 7 drill holes
Sheet size: 8-1/2" x 5-3/4"



91721 – Roll
61721 – Ring



91722 – Roll
61722 – Ring



91723 – Roll
61723 – Ring



91724 – Roll
61724 – Ring



91725 – Roll
61725 – Ring



91726 – Roll
61726 – Ring



91727 – Roll
61727 – Ring



91728 – Roll
61728 – Ring



91729 – Roll
61729 – Ring



91730 – Roll
61730 – Ring



91731 – Roll
61731 – Ring



91732 – Roll
61732 – Ring



91733 – Roll
61733 – Ring



91734 – Roll
61734 – Ring



91735 – Roll
61735 – Ring



91736 – Roll
61736 – Ring



91737 – Roll
61737 – Ring



91738 – Roll
61738 – Ring



91739 – Roll
61739 – Ring



91740 – Roll
61740 – Ring



91741 – Roll
61741 – Ring



91742 – Roll
61742 – Ring



91743 – Roll
61743 – Ring



91744 – Roll
61744 – Ring



91745 – Roll
61745 – Ring



91746 – Roll
61746 – Ring



91747 – Roll
61747 – Ring

93020 / 63020 series

Safeguard® compatible series

15/16"H x 1-5/8"W – Label size

ROLL / 500 labels per roll

Dispenser Container only – 90150
(Holds 28 Rolls)

RINGBOOK / 240 labels per pkg.
10 labels per sheet – 7 drill holes
Sheet size: 8-1/2" x 6"



93021 – Roll
63021 – Ring



93022 – Roll
63022 – Ring



93023 – Roll
63023 – Ring



93024 – Roll
63024 – Ring



93025 – Roll
63025 – Ring



93026 – Roll
63026 – Ring



93027 – Roll
63027 – Ring



93028 – Roll
63028 – Ring



93029 – Roll
63029 – Ring



93030 – Roll
63030 – Ring



93031 – Roll
63031 – Ring



93032 – Roll
63032 – Ring



93033 – Roll
63033 – Ring



93034 – Roll
63034 – Ring



93035 – Roll
63035 – Ring



93036 – Roll
63036 – Ring



93037 – Roll
63037 – Ring



93038 – Roll
63038 – Ring



93039 – Roll
63039 – Ring



93040 – Roll
63040 – Ring



93041 – Roll
63041 – Ring



93042 – Roll
63042 – Ring



93043 – Roll
63043 – Ring



93044 – Roll
63044 – Ring



93045 – Roll
63045 – Ring



93046 – Roll
63046 – Ring



93047 – Roll
63047 – Ring

compatible color code labels

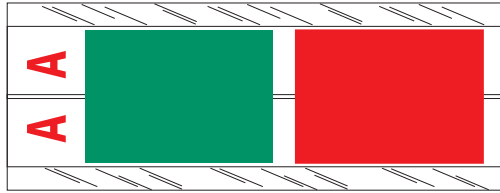

12700 series
Acme Visible® compatible series

4"H x 1-1/2"W – Label size

PACK / 102 labels per pkg.
3 labels per strip

Sheet size: 12" x 1-1/2"
Original Col'RTab® construction

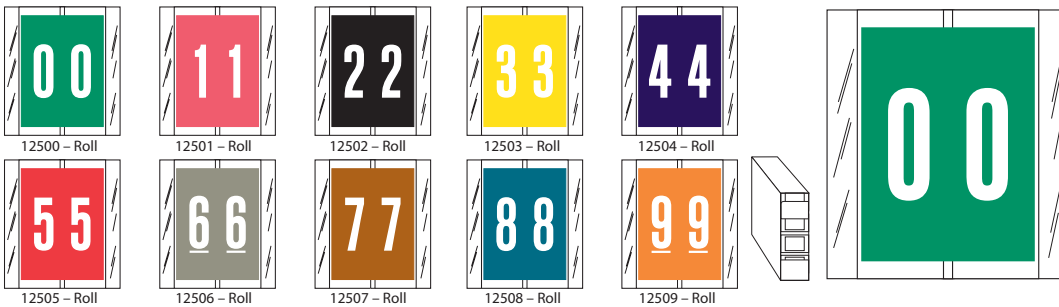

12500 series
Acme Visible® compatible series

1-2/3"H x 1-1/2"W – Label size
Original Col'RTab® construction

ROLL / 500 labels per roll

Dispenser Container only – 11015
(Holds 10 Rolls)

**Call for availability on
double digit labels.**

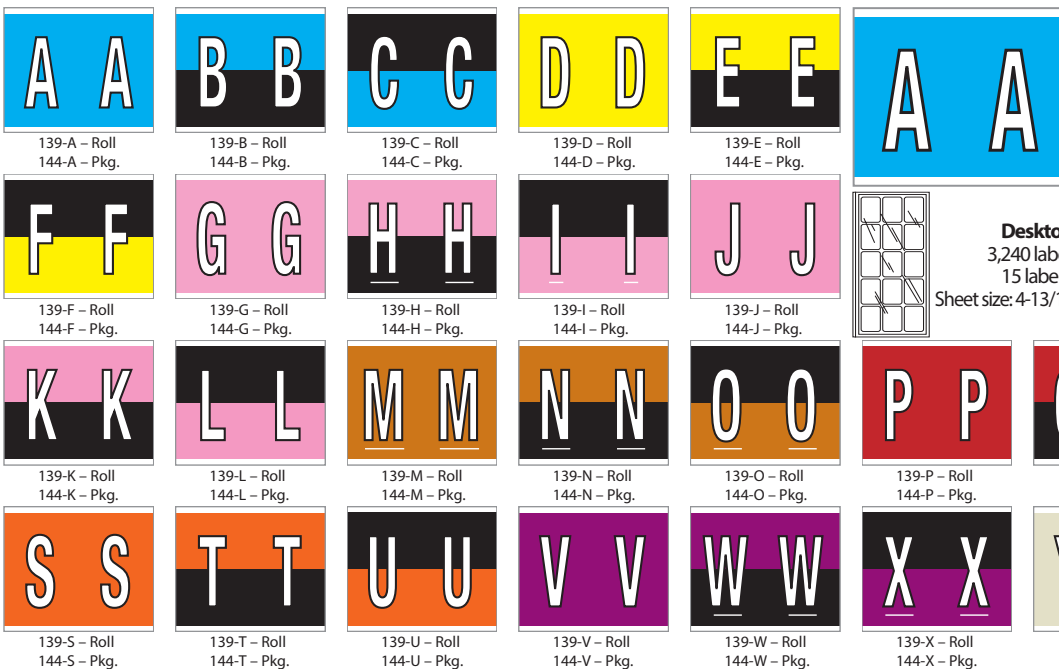

139 & 144 series
Kardex® compatible series

1-1/4"H x 1-1/2"W – Label size

ROLL / 500 labels per roll

PACK / 210 labels per pkg.
15 labels per sheet
Sheet size: 4-13/16" x 6-7/8"

Desktop Kit – 142
3,240 labels per pkg.
15 labels per sheet
Sheet size: 4-13/16" x 6-7/8"

Pack Set – 143
1,725 labels per pkg.
15 labels per sheet
Sheet size: 4-13/16" x 6-7/8"

compatible color code labels

138 / 140 series Kardex® compatible series

138 series
1-1/4"H x 1-1/2"W – Label size
ROLL / 500 labels per roll

140 series
1/2"H x 1"W – Label size
ROLL / 1500 labels per roll

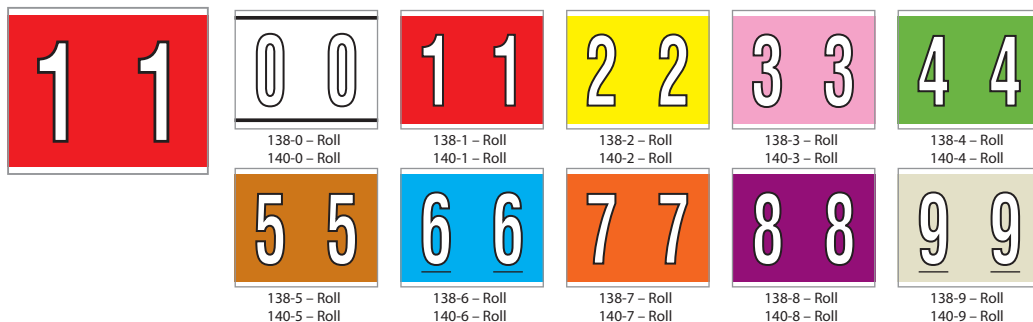

91620 / 71620 series Barkley® ABKM compatible series

1"H x 1-1/2"W – Label size
ROLL / 500 labels per roll
Roll Unit – 31620 (28 rolls)
Dispenser Container only – 90150
(Holds 28 Rolls)
PACK / 252 labels per pkg.
9 labels per sheet
Sheet size: 5" x 3-3/8"
Desktop Kit – 71620 (2,016 labels)

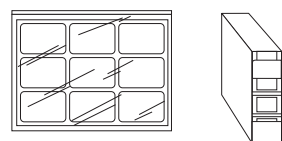
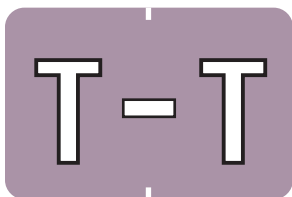

91600 / 71600 series Barkley® NBKM compatible series

1"H x 1-1/2"W – Label size
ROLL / 500 labels per roll
Roll Unit – 31600 (10 rolls)
Dispenser Container only – 90110
(Holds 10 Rolls)
PACK / 252 labels per pkg.
9 labels per sheet
Sheet size: 5" x 3-3/8"

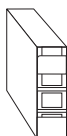

compatible color code labels



91420 / 61420 series
Colwell® Jewel-Tone compatible series

1"H x 1-1/2"W – Label size

ROLL / 500 labels per roll
Roll Unit – 91420 (28 rolls)

Dispenser Container only – 90150
(Holds 28 Rolls)

RINGBOOK / 240 labels per pkg.
24 labels per sheet / 3 drill holes
Sheet size: 5-1/2" x 9"

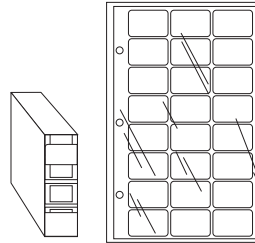

91400 series
Colwell® Jewel-Tone compatible series

1"H x 1-1/2"W – Label size

ROLL / 500 labels per roll
Roll Unit – 91410 (10 rolls)

Dispenser Container only – 90110
(Holds 10 Rolls)

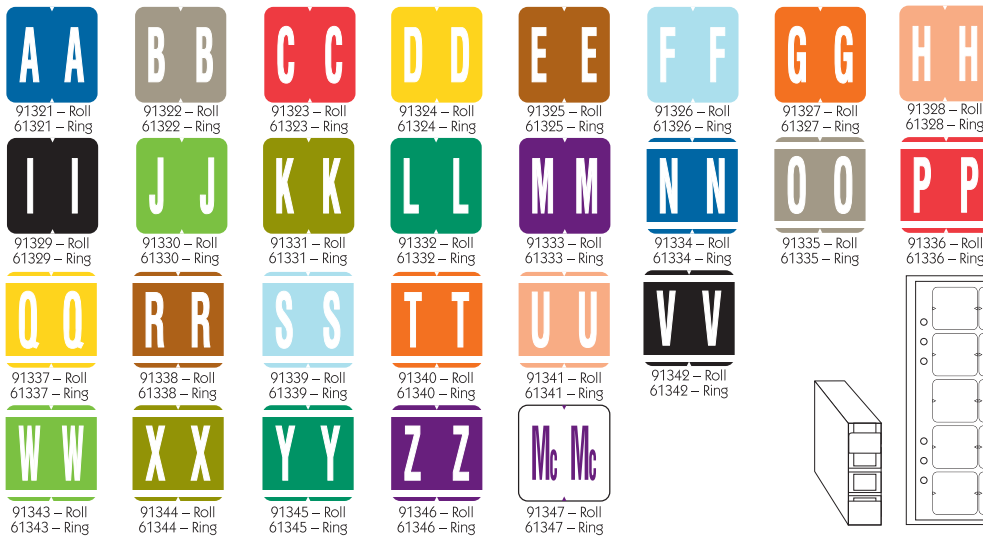
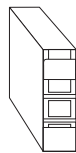
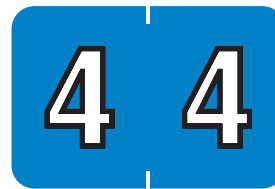

91320 / 61320 series
GBS® / VRE® 8848/8850 compatible series

1-5/16"H x 1-1/4"W – Label size

ROLL / 550 labels per roll
Roll Unit – 91320 (27 rolls)

RINGBOOK / 200 labels per pkg.
10 labels per sheet / 6 drill holes
Sheet size: 3-1/4" x 6-3/4"

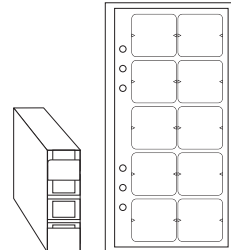

91300 series
GBS® / VRE® compatible series

1-5/16"H x 1-1/4"W – Label size

ROLL / 550 labels per roll
Roll Unit – 91310 (10 rolls)



compatible color code labels

14610 series GBS® / VRE® compatible series

1-5/16"H x 1-1/2"W – Label size
Original Col'R'Tab® construction

ROLL / 500 labels per roll

Dispenser Container only – 12000
(Holds 30 Rolls)

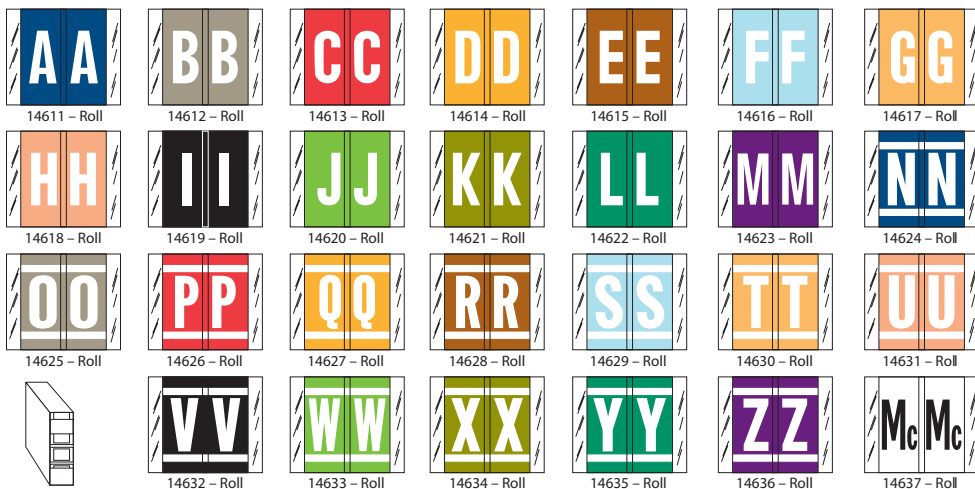
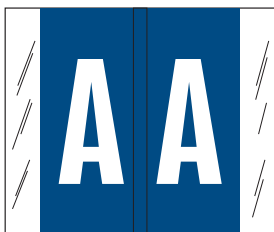

14600 series GBS® / VRE® compatible series

1-5/16"H x 1-1/2"W – Label size
Original Col'R'Tab® construction

ROLL / 500 labels per roll

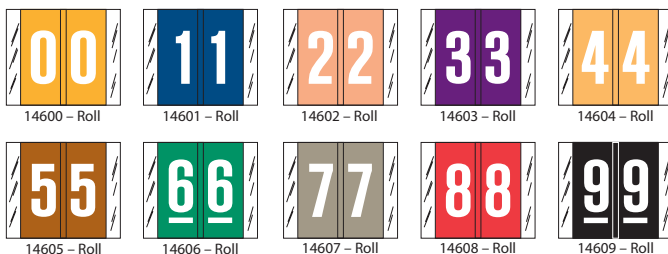
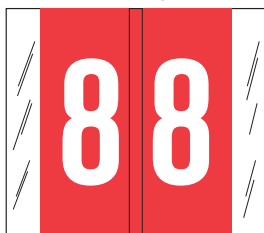

call for availability on double digit labels

Dispenser Container only – 11015
(Holds 10 Rolls)



91120 / 71120 series Tab Products® & Jeter® 5100 compatible series

15/16"H x 1-1/2"W – Label size
Laminated finish

ROLL / 500 labels per roll

Roll Unit – 31120 (28 rolls)

PACK / 252 labels per pkg.

9 labels per sheet

Sheet size: 5" x 3-1/2"

Desktop Kit – 71120 (2,016 labels)



Dispenser Container only – 90150
(Holds 28 Rolls)

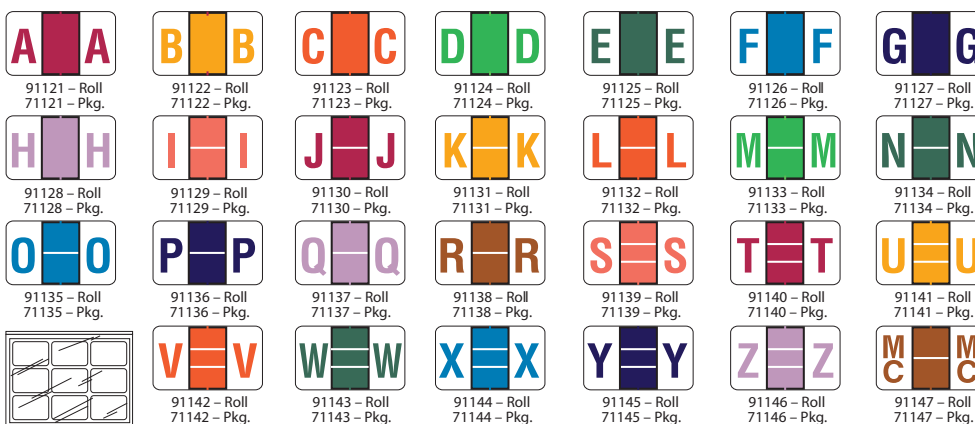

91100 / 71100 series Tab Products® & Jeter® 6100 compatible series

15/16"H x 1-1/2"W – Label size
Laminated finish

ROLL / 500 labels per roll

Roll Unit – 31100 (10 rolls)

PACK / 252 labels per pkg.

9 labels per sheet





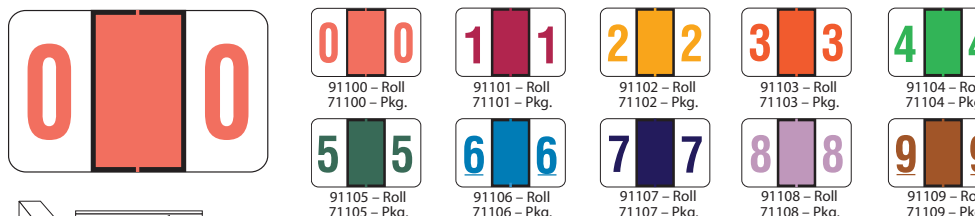













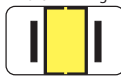









Sheet size: 5" x 3-1/2"

Desktop Kit – 71110 (2,016 labels)

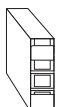
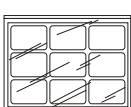

Dispenser Container only – 90110
(Holds 10 Rolls)

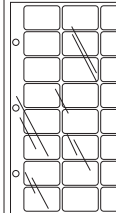
compatible color code labels

 91521 - Roll 71521 - Pkg. 61521 - Ring	 91522 - Roll 71522 - Pkg. 61522 - Ring	 91523 - Roll 71523 - Pkg. 61523 - Ring	 91524 - Roll 71524 - Pkg. 61524 - Ring	 91525 - Roll 71525 - Pkg. 61525 - Ring	 91526 - Roll 71526 - Pkg. 61526 - Ring	 91527 - Roll 71527 - Pkg. 61527 - Ring	
 91528 - Roll 71528 - Pkg. 61528 - Ring	 91529 - Roll 71529 - Pkg. 61529 - Ring	 91530 - Roll 71530 - Pkg. 61530 - Ring	 91531 - Roll 71531 - Pkg. 61531 - Ring	 91532 - Roll 71532 - Pkg. 61532 - Ring	 91533 - Roll 71533 - Pkg. 61533 - Ring	 91534 - Roll 71534 - Pkg. 61534 - Ring	
 91535 - Roll 71535 - Pkg. 61535 - Ring	 91536 - Roll 71536 - Pkg. 61536 - Ring	 91537 - Roll 71537 - Pkg. 61537 - Ring	 91538 - Roll 71538 - Pkg. 61538 - Ring	 91539 - Roll 71539 - Pkg. 61539 - Ring	 91540 - Roll 71540 - Pkg. 61540 - Ring	 91541 - Roll 71541 - Pkg. 61541 - Ring	
 91542 - Roll 71542 - Pkg. 61542 - Ring	 91543 - Roll 71543 - Pkg. 61543 - Ring	 91544 - Roll 71544 - Pkg. 61544 - Ring	 91545 - Roll 71545 - Pkg. 61545 - Ring				
 91546 - Roll 71546 - Pkg. 61546 - Ring	 91547 - Roll 71547 - Pkg. 61547 - Ring						

91520 / 71520 / 61520 series
Jeter® 5800, 7100, 7200
compatible series

15/16"H x 1-5/8"W - Label size













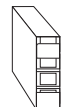

ROLL / 500 labels per roll
Roll Unit - 91520 (28 rolls)

Dispenser Container only - 90150
(Holds 28 Rolls)

PACK / 252 labels per pkg.
9 labels per sheet
Sheet size: 5-1/4" x 3-1/4"

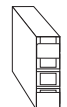
Desktop Kit - 71520 (2,016 labels)

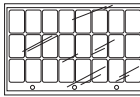
RINGBOOK / 240 labels per pkg.
24 labels per sheet / 3 drill holes
Sheet size: 5-3/4" x 8-1/2"



























 91500 - Roll	 91501 - Roll	 91502 - Roll	 91503 - Roll				
 91504 - Roll	 91505 - Roll	 91506 - Roll	 91507 - Roll				
 91508 - Roll	 91509 - Roll						

91500 series
Jeter® 7300 compatible series

15/16"H x 1-5/8"W - Label size

ROLL / 500 labels per roll



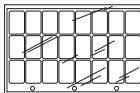







Dispenser Container only - 90110
(Holds 10 Rolls)

 62241 - Ring	 62242 - Ring	 62243 - Ring	 62244 - Ring	 62245 - Ring	 62246 - Ring	 62247 - Ring
 62248 - Ring	 62249 - Ring	 62250 - Ring	 62251 - Ring	 62252 - Ring	 62253 - Ring	 62254 - Ring
 62255 - Ring	 62256 - Ring	 62257 - Ring	 62258 - Ring	 62259 - Ring	 62260 - Ring	 62261 - Ring
 62262 - Ring	 62263 - Ring	 62264 - Ring	 62265 - Ring	 62266 - Ring	 62267 - Ring	

62240 series
POS® 2000 compatible series

15/16"H x 1-5/8"W - Label size

RINGBOOK / 240 labels per pkg.
24 labels per sheet / 3 drill holes
Sheet size: 5-3/4" x 8-1/2"

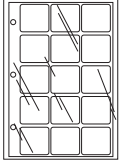
 62231-AB - Ring	 62232-C - Ring	 62233-DEF - Ring	 62234-GHI - Ring	 62235-J - Ring	
 62236-KL - Ring	 62237-MNO - Ring	 62238-PQR - Ring	 62239-ST - Ring	 62240-UZ - Ring	

62230 multi-letter series
POS® 3700 compatible series

1-1/2"H x 1-1/2"W - Label size

RINGBOOK / 150 labels per pkg.
15 labels per sheet / 3 drill holes
Sheet size: 5-1/2" x 8-1/2"

compatible color code labels

91920 series Smead® NCC compatible series

1-5/32"H x 3-5/8"W – Label size
PACK / 100 labels per pkg.
 5 labels per sheet
 Sheet size: 3-3/4" x 5-7/8"
Desktop Kit – 31920 (1,500 labels)

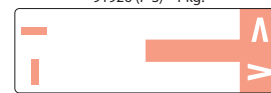
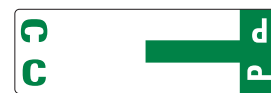
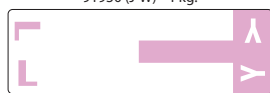
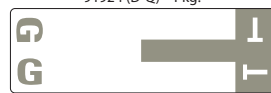
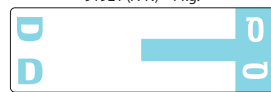
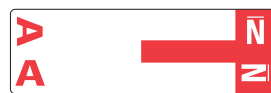
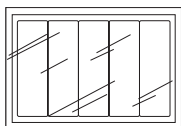

91820 / 71820 series Smead® ACC & ACCS compatible series

1-5/8"H x 1"W – Label size
ROLL / 250 labels per roll
Roll Unit – 41820 (26 rolls)
 Dispenser Container only – 90150
 (Holds 26 Rolls)
PACK / 108 labels per pkg.
 9 labels per sheet
 Sheet size: 5-1/4" x 3-3/8"

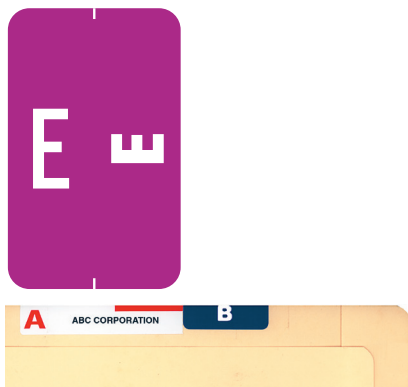

91800 series Smead® LCC compatible series

2"H x 1"W – Label size
ROLL / 250 labels per roll
Roll Unit – 41800 (10 rolls)
 Dispenser Container only – 90110
 (Holds 10 Rolls)

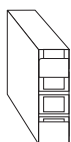

compatible color code labels

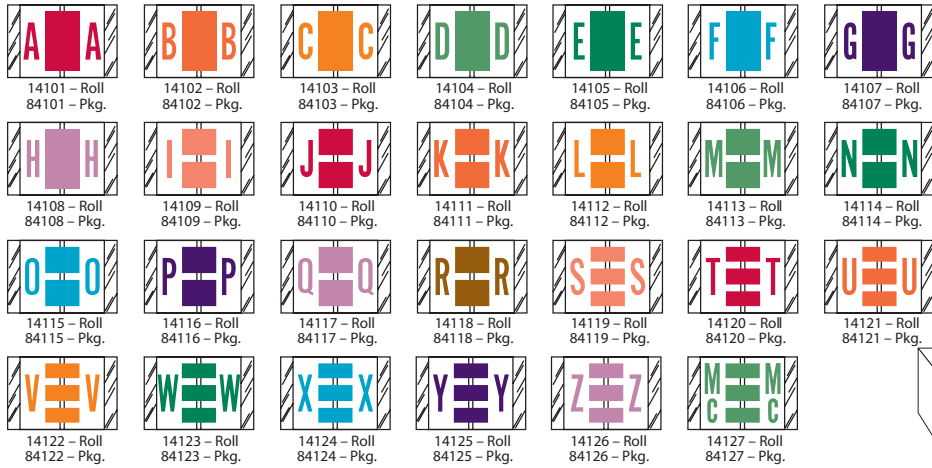

14100 / 84100 series Tab Products® compatible series

1"H x 1-1/2"W – Label size
Original Col'RTab® construction
ROLL / 500 labels per roll
Dispenser Container only – 12000
(Holds 30 Rolls)
PACK / 100 labels per pkg.
10 labels per strip
Sheet size: 10" x 1-1/2"

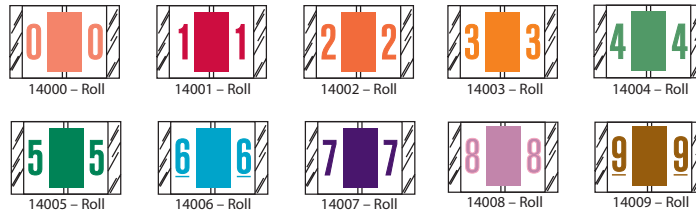
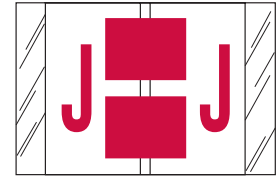

Dispenser Container only – 11015
(Holds 10 Rolls)



14000 series Tab Products® compatible series

1"H x 1-1/2"W – Label size
Original Col'RTab® construction
ROLL / 500 labels per roll

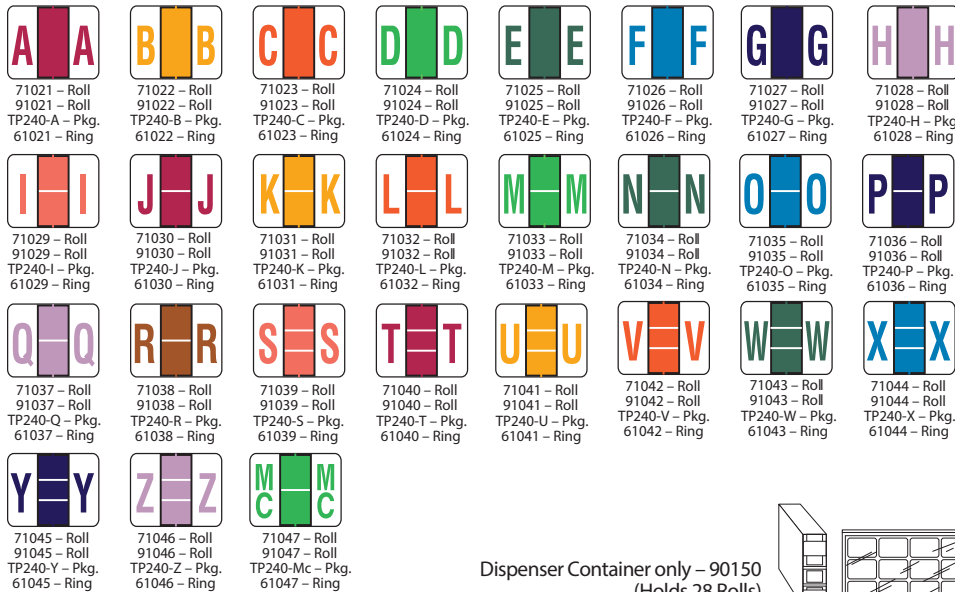

Dispenser Container only – 90150
(Holds 28 Rolls)

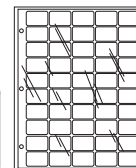

71020 series (Kimdura) rolls 91020 series (Paper laminated) rolls TP240 series (Paper laminated) pack Tab Products® 1283, 1286 & Smead® BCCS & BCCR compatible series 61020 series (Kimdura) ringbook sheets

1"H x 1-1/4"W – Label size
ROLL / 71020 Series – 500 labels per roll
Roll Unit – 71020 - Kimdura (28 rolls)
ROLL / 91020 Series – 500 labels per roll
Roll Unit – 41020 - Laminated (28 rolls)
PACK / 240 labels per pkg.
12 labels per sheet
Sheet size: 5-1/2" x 3-3/8"
RINGBOOK / 250 labels per pkg.
50 labels per sheet / 3 drill holes
Sheet size: 7-1/4" x 11-1/4"

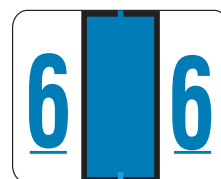
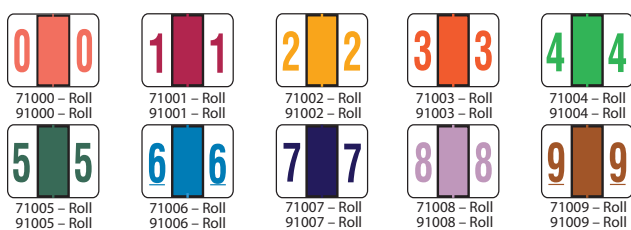

71000 series (Kimdura) 91000 series (Paper laminated) Tab Products® 1282 & Smead® BCCRN compatible series

1"H x 1-1/4"W – Label size
ROLL / 71000 Series – 500 labels per roll
Roll Unit – 71010 - Kimdura (10 rolls)
ROLL / 91000 Series – 500 labels per roll
Roll Unit – 91010 - Laminated (10 rolls)
Dispenser Container only – 90110
(Holds 10 Rolls)

compatible color code labels

71220 series Tab Products® compatible series

1/2"H x 1"W – Label size
(Laminated)
ROLL / 500 labels per roll
Dispenser Container only – 90150
(Holds 28 Rolls)

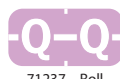

71200 series Tab Products® compatible series

1/2"H x 1"W – Label size
(Laminated)
ROLL / 500 labels per roll
Dispenser Container only – 90110
(Holds 10 Rolls)



90120 series Original Tabbies®

15/16"H x 1-1/2"W – Label size
ROLL / 500 labels per roll



Dispenser Container only – 90150
(Holds 28 Rolls)

90100 series Original Tabbies®

15/16"H x 1-1/2"W – Label size
ROLL / 500 labels per roll



Dispenser Container only – 90110
(Holds 10 Rolls)

70230 series Original Tabbies®

1/2"H x 1"W – Label size
PACK / 100 labels per pkg.
25 labels per sheet
Sheet size: 5-5/8" x 3-1/8"

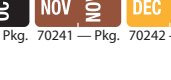
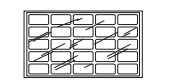
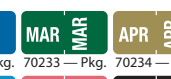

compatible color code labels



94900 series
Ames® compatible series
1-7/8"H x 1-7/8"W – Label size
ROLL / 500 labels per roll

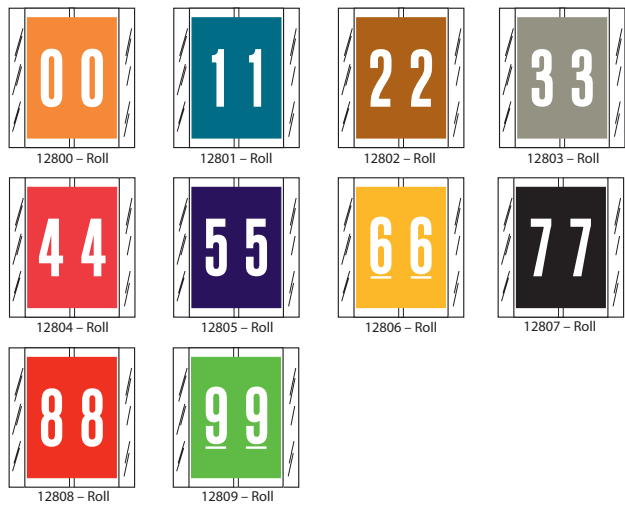
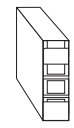

12800 series
SFI® compatible series
1-2/3"H x 1-1/2"W – Label size
Original Col'RTab® construction
ROLL / 500 labels per roll

Dispenser Container only – 11015
(Holds 10 Rolls)

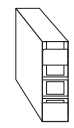
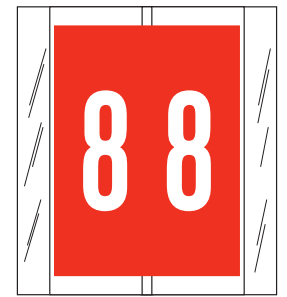

70520 series
Original Tabbies®

1"H x 1-1/2"W – Label size
PACK / 252 labels per pkg.
9 labels per sheet
Sheet size: 5" x 3-1/4"

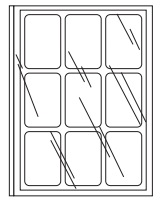

91980 series
Jeter® 9500 compatible series

3/4"H x 1-1/2"W – Label size
ROLL / 500 labels per roll

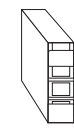

compatible color code labels

11600 series Original Col'R'Tab®

1-1/2"H x 1-1/2"W – Label size

ROLL / 500 labels per roll

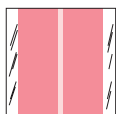
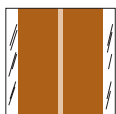
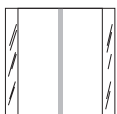
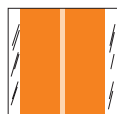
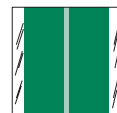
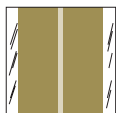
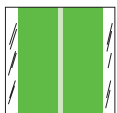
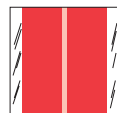
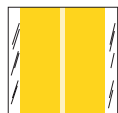
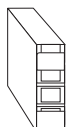
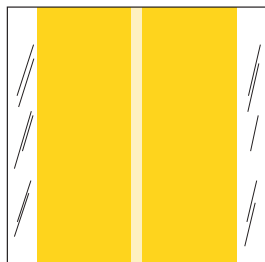

11100 series Original Col'R'Tab®

1"H x 1-1/2"W – Label size

ROLL / 500 labels per roll

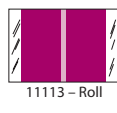
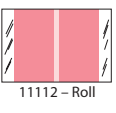
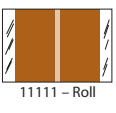
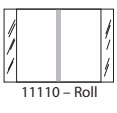
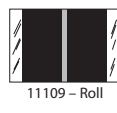
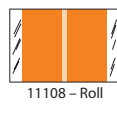
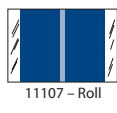
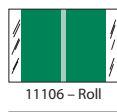
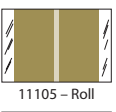
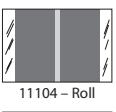
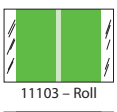
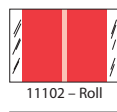
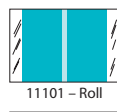
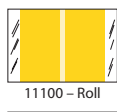
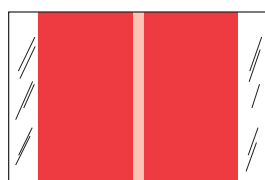

53300 series Kardex® compatible series

3/8"H x 1-7/16"W – Label size
Original Col'R'Tab® construction

ROLL / 1,000 labels per roll

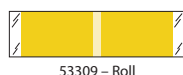
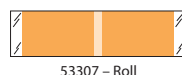
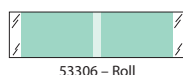
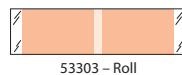
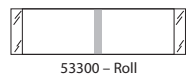

53500 series Kardex® compatible series

1/2"H x 1-7/16"W – Label size
Original Col'R'Tab® construction

ROLL / 1,000 labels per roll

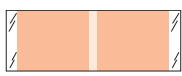

53110 series Kardex® compatible series

5/16"H x 1-7/16"W – Label size
Original Col'R'Tab® construction

ROLL / 2,000 labels per roll



yearcode labels

11700 / 51700 / 81700 series Original Col'R'Tab®

3/4"H x 1-1/2"W – Label size
1,000 labels per roll • 500 labels per roll • 250 labels per pkg.

stock no. 1,000/roll	stock no. 500/roll	stock no. 250/pkg	item	color
11713	51713	81713	13	Lt. Green
11714	51714	81714	14	Gray
11715	51715	81715	15	Gold
11716	51716	81716	16	Green
11717	51717	81717	17	Blue
11718	51718	81718	18	Orange
11719	51719	81719	19	Black
11720	51720	81720	20	Yellow
11721	51721	81721	21	Lt. Blue
11722	51722	81722	22	Red
11723	51723	81723	23	Lt. Green



11718 – Roll • 51718 – Roll • 81718 – Pkg.



11719 – Roll • 51719 – Roll • 81719 – Pkg.



11720 – Roll • 51720 – Roll • 81720 – Pkg.

71700 series Original Col'R'Tab®

1-1/2"H x 3/4"W (Top Tab) – Label size
1,000 labels per roll

stock no.	item	color
71713	13	Lt. Green
71714	14	Gray
71715	15	Gold
71716	16	Green
71717	17	Blue
71718	18	Orange
71719	19	Black
71720	20	Yellow
71721	21	Lt. Blue
71722	22	Red
71723	23	Lt. Green



71718 – Roll



71719 – Roll



71720 – Roll

70200 series Original Tabbies®

3/4"H x 1-1/2"W – Label size
500 labels per roll

stock no.	item	color
70213	13	Dk. Green
70214	14	Gold
70215	15	Gray
70216	16	Lt. Green
70217	17	Red
70218	18	Lt. Blue
70219	19	Pink
70220	20	Black
70221	21	Orange
70222	22	Blue
70223	23	Dk. Green



70218 – Roll



70219 – Roll



70220 – Roll

70500 series Original Tabbies®

1"H x 1/2"W (Top Tab) – Label size
250 labels per pkg.

stock no.	item	color
70513	13	Dk. Green
70514	14	Gold
70515	15	Gray
70516	16	Lt. Green
70517	17	Red
70518	18	Lt. Blue
70519	19	Pink
70520	20	Black
72521	21	Orange
72522	22	Blue
72523	23	Dk. Green



70518 – Pkg.



70519 – Pkg.



70520 – Pkg.

12600 series Acme Visible® compatible series

3/4"H x 1-1/2"W – Label size
1,000 labels per roll
Original Col'R'Tab® construction

stock no.	item	color
12613	13	Yellow
12614	14	Purple
12615	15	Red
12616	16	Gray
12617	17	Brown
12618	18	Blue
12619	19	Orange
12620	20	Green
12621	21	Pink
12622	22	Black
12623	23	Yellow



12618 – Roll



12619 – Roll



12620 – Roll

14900 series Ames® compatible series

1-7/8"H x 1-7/8"W – Label size
500 labels per roll

stock no.	item	color
14913	13	Orange
14914	14	Purple
14915	15	Black
14916	16	Yellow
14917	17	Brown
14918	18	Pink
14919	19	Green
14920	20	Red
14921	21	Gray
14922	22	Blue
14923	23	Orange

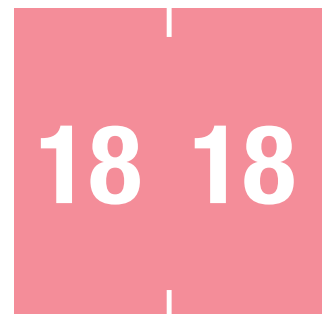

14918 – Roll



14919 – Roll



14920 – Roll

12900 series SFI® compatible series

3/4"H x 1-1/2"W – Label size
1,000 labels per roll
Original Col'R'Tab® construction



12918 – Roll

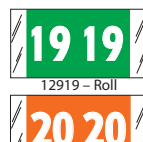

12919 – Roll

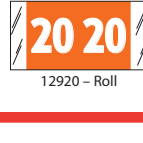

12920 – Roll

stock no.	item	color
12913	13	Gray
12914	14	Red
12915	15	Purple
12916	16	Org./Yel.
12917	17	Black
12918	18	Pink

stock no.	item	color
12919	19	Green
12920	20	Orange
12921	21	Blue
12922	22	Brown
12923	23	Gray

yearcode labels

90600 series Barkley® compatible series

3/4"H x 1-1/2"W – Label size
500 labels per roll

stock no.	item	color
90613	13	Orange
90614	14	Lt. Green
90615	15	Blue
90616	16	Lilac
90617	17	Brown
90618	18	Gray
90619	19	Gold
90620	20	Red
90621	21	Pink
90622	22	Yellow
90623	23	Orange



90618 – Roll



90619 – Roll



90620 – Roll



14418 – Roll



14419 – Roll



14420 – Roll

14400 series Colwell® compatible series

3/4"H x 1-1/2"W – Label size
500 labels per roll

stock no.	item	color
14413	13	Brown
14414	14	Blue
14415	15	Pink
14416	16	Orange
14417	17	Green
14418	18	Purple
14419	19	Lt. Orange
14420	20	Yellow
14421	21	Red
14422	22	Dk. Green
14423	23	Brown

14700 Digi-Kolor® series Original Col'R'Tab®

3/4"H x 1-1/2"W – Label size
1,000 labels per roll
Original Col'R'Tab® construction

stock no.	item	color
14713	13	Lt. Green
14714	14	Pink
14715	15	Gold
14716	16	Dk. Green
14717	17	Gray
14718	18	Orange
14719	19	Brown
14720	20	Yellow
14721	21	Blue
14722	22	Red
14723	23	Lt. Green



14718 – Roll



14719 – Roll



14720 – Roll



94618 – Roll



94619 – Roll

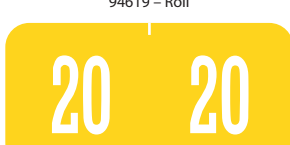

94620 – Roll

94600 series GBS®/VRE® compatible series

3/4"H x 1-1/2"W – Label size
500 labels per roll

stock no.	item	color
94613	13	Purple
94614	14	Orange
94615	15	Brown
94616	16	Green
94617	17	Gray
94618	18	Red
94619	19	Black
94620	20	Yellow
94621	21	Blue
94622	22	Pink
94623	23	Purple

90500 series Jeter® compatible series

3/4"H x 1-1/2"W – Label size
500 labels per roll

stock no.	item	color
90513	13	Purple
90514	14	Gold
90515	15	Black
90516	16	Orange
90517	17	White/Black
90518	18	Aqua
90519	19	Gray
90520	20	Blue
90521	21	Yellow
90522	22	Red
90523	23	Purple



90518 – Roll



90519 – Roll



90520 – Roll

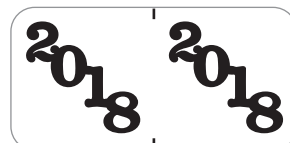

90418 – Roll



90419 – Roll



90420 – Roll

90400 series Jeter® compatible series

3/4"H x 1-1/2"W – Label size
500 labels per roll

stock no.	item	color
90413	13	Blue
90414	14	Red
90415	15	Green
90416	16	Gray
90417	17	Fushcia
90418	18	Black/White
90419	19	Orange
90420	20	Yellow
90421	21	Black
90422	22	Pink
90423	23	Blue

yearcode labels

21800 / 90800 series Smead® compatible series

1/2"H x 1"W – Label size
500 labels per roll • 250 labels per pkg.

stock no.	stock no.	item	color
500/roll	250/pkg		
90813	21813	13	Purple
90814	21814	14	Orange
90815	21815	15	Brown
90816	21816	16	Green
90817	21817	17	Gray
90818	21818	18	Red
90819	21819	19	Black
90820	21820	20	Yellow
90821	21821	21	Lt. Blue
90822	21822	22	Pink
90823	21823	23	Purple



21818-Pkg • 90818-Roll



21819-Pkg • 90819-Roll



21820-Pkg • 90820-Roll



92018 – Roll



92019 – Roll



92020 – Roll

92000 series Tab Products® compatible series

3/4"H x 1-1/2"W – Label size
500 labels per roll • Laminated

stock no.	item	color
92013	13	Dk. Orange
92014	14	Lt. Green
92015	15	Dk. Green
92016	16	Blue
92017	17	Purple
92018	18	Lilac
92019	19	Brown
92020	20	Pink
92021	21	Red
92022	22	Lt. Orange
92023	23	Dk. Orange

70800 series Smead® compatible series

1"H x 1/2"W (Top Tab) – Label size
500 labels per roll

stock no.	item	color
70813	13	Purple
70814	14	Orange
70815	15	Brown
70816	16	Green
70817	17	Gray
70818	18	Red
70819	19	Black
70820	20	Yellow
70821	21	Lt. Blue
70822	22	Pink
70823	23	Purple



70818 – Roll



70819 – Roll



70820 – Roll



91218 – Roll



91219 – Roll



91220 – Roll

91200 series Tab Products® compatible series

1/2"H x 1-1/8"W – Label size
500 labels per roll • Kimdura

stock no.	item	color
91213	13	Dk. Orange
91214	14	Lt. Green
91215	15	Dk. Green
91216	16	Blue
91217	17	Purple
91218	18	Lilac
91219	19	Brown
91220	20	Pink
91221	21	Red
91222	22	Lt. Orange
91223	23	Dk. Orange

90900 series Smead® compatible series

3/4"H x 1-1/2"W – Label size
500 labels per roll



90918 – Roll



90919 – Roll



90920 – Roll

stock no.	item	color
90913	13	Purple
90914	14	Gold
90915	15	Black
90916	16	Orange
90917	17	White/Black
90918	18	Aqua

stock no.	item	color
90919	19	Gray
90920	20	Blue
90921	21	Yellow
90922	22	Red
90923	23	Purple

97100 series PMA compatible series

3/4"H x 1-1/2"W – Label size
500 labels per roll



97118 – Roll



97119 – Roll

97120 – Roll

stock no.	item	stock no.	item	stock no.	item	stock no.	item	stock no.	item	stock no.	item	color
97115	15	97116	16	97117	17	97118	18	97119	19	97120	20	Aqua-Holographic
97215	15	97216	16	97217	17	97218	18	97219	19	97220	20	Blue-Holographic
97315	15	97316	16	97317	17	97318	18	97319	19	97320	20	Green-Holographic
97415	15	97416	16	97417	17	97418	18	97419	19	97420	20	Orange-Holographic
97515	15	97516	16	97517	17	97518	18	97519	19	97520	20	Red-Holographic
97615	15	97616	16	97617	17	97618	18	97619	19	97620	20	Purple-Holographic



tabbies®



www.tabbies.com

www.tabbiestomlabels.com



*Family owned & operated
since 1955*

Manufacturer #084371

OTHER CATALOGS AVAILABLE:

- Custom Label and Print Guide**
- Filing, Indexing & Labeling Products**
- Legal Filing, Indexing & Labeling Products**
 - Religious Products**
- Shipping & Handling Products**
- Veterinary Filing Products**