



NO KNOWN ALLERGIES

OWN FOOD

SURGERY DO NOT FEED OR WATER TODAY

WILL BITE

GIVE WITH FOOD

BATH

MEDICATION ADDED TO I.V.

15

DENTAL

PHYSICAL EXAMINATION

URINALYSIS

Veterinary Filing, Indexing & Labeling Products Catalog

simple solutions @ work®



animal alert cards

MARKETING & CLIENT GIVEAWAYS



animal alert card is self-laminating to seal in the written information. Folds to the size of a credit card and is perfect as a giveaway for: Veterinary Offices, Kennel Clubs, Animal Associations, Pet Stores, and much more...

- 54661** Animal Alert Card – 25 / pkg
3-3/8"Wx2-1/8"H
- 34661** Animal Alert Card 150 Card/Display
3-1/8"Dx2-3/4"Wx9-1/8"H
- AMLDS** Animal Alert Card Acrylic Display
w/label and placard only
3-1/8"Dx2-3/4"Wx9-1/8"H



Call for pricing on Personalized Cards.

Imprint area: 1-1/2"W x 1/2"H

cage identification cards

Maintain accurate information for animals kept onsite with these easy to use **cage identification cards**. All designs are 5" x 3" printed on sturdy white card stock that fit into any standard cage card holders.



NAME:	SEX:	TAG NO.:	DATE IN:
OWNER:	PHONE #1:	PHONE #2:	EST. DATE OUT:
SPECIAL INSTRUCTIONS:			

V-AN500 White – 52 Pkg. 5"W x 3"H (*)

OWNER:	NAME:							
DEPARTURE DATE:								
FED	AM	PM	AM	PM	AM	PM	AM	PM
ATE								
WATER								
URINE								
STOOL								
MEDS								
WALKED								

V-AN501 Red – 52 Pkg. 5"W x 3"H (*)

care instruction labels



V-AN209 Fl-Pink – 560 / Roll
1-5/8"W x 7/8"H (R)



V-AN280 Fl-Yellow – 560 / Roll
1-5/8"W x 7/8"H (R)

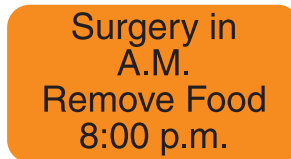

V-AN604 Fl-Orange – 560 / Roll
1-5/8"W x 7/8"H (R)



V-AN443 Fl-Red – 560 / Roll
1-5/8"W x 7/8"H (R)



V-AN291 Fl-Orange – 560 / Roll
1-5/8"W x 7/8"H (R)



V-AN216 Fl-Orange – 560 / Roll
1-5/8"W x 7/8"H (R)



V-AN284 Fl-Orange – 560 / Roll
1-5/8"W x 7/8"H (R)

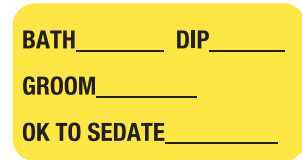

V-AN257 Fl-Yellow – 560 / Roll
1-5/8"W x 7/8"H (R)

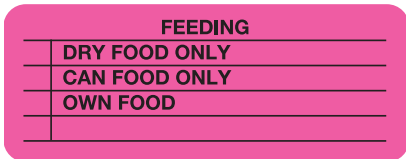

V-AN245 Fl-Pink – 420 / Roll
2-1/4"W x 7/8"H (R)

PET NAME	_____
OWNER	_____
PICK UP DATE	_____

V-AN228 White – 420 / Roll 2-1/4"W x 7/8"H (R)
V-AN401 White – 240 / Roll 4"W x 2-5/8"H (R) (*)



V-BH232 Fl-Orange – 420 / Roll
2-1/4"W x 7/8"H (P)



V-SY229 Fl-Red – 420 / Roll
2-1/4"W x 7/8"H (R)



MAP500 Fl-Green – 300 / Roll
2-1/2"W x 3/4"H (P)

care instruction labels

CAUTION

V-AN274 Fl-Red – 560 / Roll
1-5/8"W x 7/8"H (R)

**DO NOT FEED
OR WATER**

V-AN213 Fl-Green – 560 / Roll
1-5/8"W x 7/8"H (R)

PET CARRIER

PATIENT: _____

V-AN642 Fl-Yellow – 560 / Roll
1-5/8"W x 7/8"H (R)

**WILL
BITE**

V-AN244 Black/Fl-Red Type – 560 / Roll
1-5/8"W x 7/8"H (R)

**SURGERY
DO NOT FEED OR
WATER TODAY**

V-AN220 Fl-Pink – 560 / Roll
1-5/8"W x 7/8"H (R)

SPECIAL DIET

V-AN254 Fl-Yellow – 560 / Roll
1-5/8"W x 7/8"H (R)

**ON
MEDICATION**

V-AN275 Fl-Pink – 560 / Roll
1-5/8"W x 7/8"H (R)

OWN FOOD

V-AN620 Fl-Green – 560 / Roll
1-5/8"W x 7/8"H (R)

**SAVE
STOOL**

V-AN210 Fl-Pink – 560 / Roll
1-5/8"W x 7/8"H (R)

CAT CARRIER
PATIENT: _____

V-AN281 Fl-Orange – 560 / Roll
1-5/8"W x 7/8"H (R)

**APPROACH
SLOWLY**

V-AN278 Fl-Red – 560 / Roll
1-5/8"W x 7/8"H (R)

**DO NOT
FEED**

V-AN205 Fl-Pink – 560 / Roll
1-5/8"W x 7/8"H (R)

**SAVE ALL
URINE**

V-AN204 Fl-Yellow – 560 / Roll
1-5/8"W x 7/8"H (R)

BOARD

V-AN153 Lt. Blue – 560 / Roll
1-5/8"W x 7/8"H (R)

**MIGHT
BITE**

V-AN156 Fl-Pink – 560 / Roll
1-5/8"W x 7/8"H (R)

**REPORT
FOOD/WATER
INTAKE**

V-37233T Fl-Green – 560 / Roll
1-5/8"W x 7/8"H (R)

MUZZLE

V-AN273 Fl-Green – 560 / Roll
1-5/8"W x 7/8"H (R)

**NO
LEPTO**

V-AN612 Fl-Yellow – 560 / Roll
1-5/8"W x 7/8"H (R)

**LAB WORK
PENDING**

V-AN260 Fl-Yellow – 560 / Roll
1-5/8"W x 7/8"H (R)

**PAPER LITTER
ONLY**

V-AN609 Fl-Orange – 560 / Roll
1-5/8"W x 7/8"H (R)

**OK TO FEED
AND WATER**

V-AN218 Fl-Orange – 560 / Roll
1-5/8"W x 7/8"H (R)

**OBSERVING
FOR RABIES**

V-37195T Fl-Pink – 560 / Roll
1-5/8"W x 7/8"H (P)

**AGGRESSIVE
ANIMAL**

V-AN486 Black/Fl-Red Type – 560 / Roll
1-5/8"W x 7/8"H (R)

**SURGERY
TODAY**

V-AN217 Fl-Green – 560 / Roll
1-5/8"W x 7/8"H (R)

VACCINATE

V-AN222 Fl-Pink – 560 / Roll
1-5/8"W x 7/8"H (R)

**URINE
SPECIMEN**

V-AN261 Fl-Green – 560 / Roll
1-5/8"W x 7/8"H (R)

**SPECIAL
DIET**

V-AN223 Fl-Orange – 560 / Roll
1-5/8"W x 7/8"H (R)

**To Go
Home**

V-AN286 Fl-Pink – 560 / Roll
1-5/8"W x 7/8"H (R)

**FOR
EUTHANASIA**

V-AN125 Fl-Yellow – 560 / Roll
1-5/8"W x 7/8"H (R)

**CHEMOTHERAPY
Special Disposal
Urine/BM**

V-AN126 Fl-Yellow – 560 / Roll
1-5/8"W x 7/8"H (R)

**DO NOT
EXERCISE**

V-AN225 Fl-Red – 560 / Roll
1-5/8"W x 7/8"H (P)

**BRING
FRESH
STOOL
SAMPLE**

V-AN299 Fl-Orange – 885 / Roll
1" Dia (R)

allergy warning labels

MEDICAL ALERT

V-MC218 Fl-Red – 560 / Roll
1-5/8"W x 7/8"H (P)

ALLERGIC TO:

MAP3320 Fl-Orange – 250 / Roll
1-1/2"W x 7/8"H (P)

ALLERGIC TO:

MAP3350 Fl-Pink – 250 / Roll
1-1/2"W x 7/8"H (P)

I'M ALLERGIC TO CATS



ALLERGIC TO:

UL180 Fl-Red – 500 / Roll
1-5/8"W x 7/8"H (P)

NO KNOWN ALLERGIES

MAP1510 Lt-Blue – 250 / Roll
1-1/2"W x 7/8"H (P)

ALLERGIC TO:

UL439 Fl-Red – 500 / Roll
1-1/4"W x 5/16"H (P)

vaccination record labels

SITE OF VACCINATION

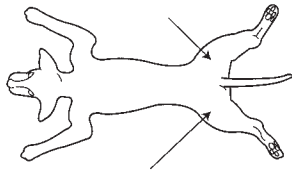

Given By: _____ DVM/CVT

V-AN451 White – 320 / Roll
2-1/2"W x 2-1/2"H (P) (*)

Patient _____	Date _____
BUN _____ Cre. _____ T. Bil. _____	
SGPT _____ Alk. P. _____ I. Bil. _____	
GLU _____ D. Bil. _____ Chol. _____	
T.P. _____ U.A. _____ Amylase _____	
GL _____ Na. _____ K. _____	
Lipase _____ P. _____ Ca. _____	
Platelet C. _____	

V-AN329 Fl-Yellow – 320 / Roll
3"W x 2"H (P) (*)

DUE _____
RABIES GIVEN _____

V-AN106 Fl-Red – 500 / Roll
1-5/8"W x 3/8"H (R) (*)

RABIES

MFG _____
SERIAL # _____
TAG # _____

V-AN601 Fl-Green – 560 / Roll
1-5/8"W x 7/8"H (P) (*)

SITE OF VACCINATION

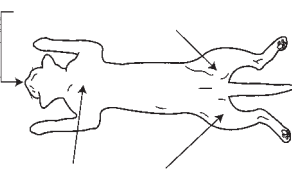

Given By: _____ DVM/CVT

V-AN452 White – 320 / Roll
2-1/2"W x 2-1/2"H (P) (*)

DA ₂ PL-PV _____	DUE _____	GIVEN _____
Corona _____		
RV _____		1-2-3 Yr
Lyme _____		
Bordetella _____		

V-AN454 Fl-Green – 420 / Roll
2-1/4"W x 7/8"H (P) (*)

inventory control & sterilization labels

AUTOCLAVEN ON _____
EXPIRES ON _____

V-SD126 Fl-Pink – 420 / Roll
2-1/4"W x 7/8"H (P) (*)

Date Rec'd _____
Date Opened _____
Exp. Date _____

V-LR138 Yellow – 560 / Roll
1-5/8"W x 7/8"H (R) (*)

DATE
OPENED

V-FP703 Fl-Yellow – 570 / Roll
3/4" Dia. (R) (*)

medical record sheets

Printed 2-sided on heavy-duty 100 lb. stock.

CANINE MEDICAL RECORD											
PATIENT		SPECIES		SEX		AGE		WEIGHT		DATE	
NAME	DOB	SEX	AGE	WEIGHT	DATE	PROBLEM LIST	MEDICATIONS	ALLERGIES	TREATMENT NOTES	WEIGHT	TEMP
PROBLEM LIST	MEDICATIONS	ALLERGIES	TREATMENT NOTES	WEIGHT	TEMP						

V-CF100 Blue – 250 / Pack
8-1/2"W x 11"H (*)

FELINE MEDICAL RECORD											
PATIENT		SPECIES		SEX		AGE		WEIGHT		DATE	
NAME	DOB	SEX	AGE	WEIGHT	DATE	PROBLEM LIST	MEDICATIONS	ALLERGIES	TREATMENT NOTES	WEIGHT	TEMP
PROBLEM LIST	MEDICATIONS	ALLERGIES	TREATMENT NOTES	WEIGHT	TEMP						

V-CF101 Green – 250 / Pack
8-1/2"W x 11"H (*)

authorization and consent labels

AUTHORIZATION TO PERFORM EUTHANASIA

Date _____

As owner, or duly authorized agent of the owner, of the animal described hereon, I hereby consent to and order, euthanasia to be performed on same for humane reasons. I further authorize the attending veterinarian to dispose of the remains in accordance with hospital policy. YES NO

To the best of my knowledge and belief this animal has not bitten any person during the fifteen days preceding this date.

Signature _____

V-AN424 White – 240 / Roll 4"W x 2-5/8"H (P) (*)

AUTHORIZATION TO PERFORM EUTHANASIA

I am the owner, or authorized agent of the owner, of the animal described hereon and I hereby consent to, and order euthanasia to be performed on the same for humane reasons, and in a humane manner.

I further authorize the attending veterinarian to dispose of the remains in accordance with hospital policy, unless otherwise instructed.

To my best knowledge and belief this animal has not bitten any person during the fifteen(15) days preceding this date.

grant/ refuse permission for a postmortem study.

Date _____ Signature _____

Name _____
Species _____
Breed _____
Sex _____
Age _____
Color _____

V-AN408 White – 240 / Roll 4"W x 2-5/8"H (P) (*)

SURGICAL AND HOSPITALIZATION AUTHORIZATION

I hereby consent and authorize _____ to receive, prescribe for, treat, or operate upon my animal(s).

You are to use all reasonable precautions against injury, escape, or destruction of the animal(s), but you will not be held liable or responsible in any manner whatever, or any circumstances, on account of the care, treatment or safekeeping of the animal(s) named below, or otherwise in connection therewith, as it is thoroughly understood that I assume all risks. Financial responsibility for services rendered is due at time of discharge.

I also understand that _____ is not staffed twenty-four (24) hours a day and afterhour treatment of patients is at the discretion of the veterinarian.

Signature _____ Date _____
Phone # _____ Name(s) _____

V-AN435 White – 240 / Roll 4"W x 2-5/8"H (P) (*)

REFUSAL OF OPTIONAL TREATMENT(S) OR MEDICAL TEST(S)

Date _____

I (print name) _____ do hereby refuse the following treatment(s) or medical test(s).

Treatment (Describe) _____
 Presurgical Screen Complete Blood Count Urinalysis
 Chemistry Panel X-rays (Describe) _____
 Other _____

For (pet's name) _____

I hereby release you Doctor _____ of all responsibility pertaining to my refusal of the above. You will not be held liable or responsible in any manner whatsoever. It is further understood that I assume all risks by my refusal of the above named treatment(s) or medical test(s).

I have read the foregoing and agree.

Owner's Signature _____
Witness _____

V-AN426 White – 240 / Roll 4"W x 2-5/8"H (P) (*)

AUTHORIZATION TO PERFORM EUTHANASIA

I am the owner, or authorized agent of the owner, of the animal described hereon and I hereby consent to, and order euthanasia to be performed on the same for humane reasons, and in a humane manner.

I further authorize the attending veterinarian to dispose of the remains in accordance with hospital policy, unless otherwise instructed.

To my best knowledge & belief this animal has not bitten any person during the fifteen(15) days preceding this date.

grant/ refuse permission for a postmortem study.

Date _____
Signature _____

V-AN405 White – 390 / Roll
2-1/2"W x 2-1/2"H (R) (*)

I have requested the following surgery(s) or procedure(s) for _____ (Pet's Name)

1. _____
 2. _____
 3. _____
- I understand and accept the risks involved.

V-AN322 White – 320 / Roll 4"W x 2"H (P) (*)

x-ray labels

**ORIGINAL
PLEASE RETURN**

UL806 Fl-Green – 420 / Roll
2-1/4"W x 7/8"H (P) (*)

**X-RAY
K.V.P.
M.A.
T.T. _____ GRID _____**

V-AN248 Lt. Blue – 420 / Roll
2-1/4"W x 7/8"H (R) (*)

**X-RAY COPIES
DO NOT RETURN**

UL807 Fl-Chartreuse – 420 / Roll
2-1/4"W x 7/8"H (P) (*)

**X-RAYS
Handle
with Care**

MAP2410 Fl-Red – 250 / Roll 1-1/2"W x 7/8"H (P) (*)

X-RAY

Name: _____ No. _____
Date: _____ DV LAT
Taken by: _____ AP
KV: _____ Exp: _____ VD

Comments: _____

V-AN417 White – 240 / Roll 4"W x 2-5/8"H (P) (*)

examination record labels

Dental Examination Records

DENTAL Name _____ Date _____

KEY: O = Displaced Tooth
X = Missing Tooth
↙ = Caries, Injury, FX

CANINE **FELINE**

MAXILLA

MANDIBLE

a _____
b _____
c _____
d _____

Gingiva: _____
Occlusion: _____

Salivation: _____

Halitosis: Y N
Periodontal Disease: _____

Other: _____

V-AN650 White - 240 / Roll
4"W x 2-5/8"H (P) (*)

CANINE DENTAL RECORD

FOR _____

R UPPER L **L LOWER R**

V-AN432 White - 390 / Roll
2-1/2"W x 2-1/2"H (P) (*)

DENTAL Name _____ Date _____

KEY: O = Displaced Tooth
X = Missing Tooth
↙ = Caries, Injury, FX

MAXILLA

MANDIBLE

a _____
b _____
c _____
d _____

Gingiva: _____
Occlusion: _____

Salivation: _____

Halitosis: Y N
Periodontal Disease: _____

Other: _____

V-AN412 White - 240 / Roll
4"W x 2-5/8"H (P) (*)

FELINE DENTAL RECORD

FOR _____

R UPPER L **L LOWER R**
FELINE

V-AN411 White - 390 / Roll
2-1/2"W x 2-1/2"H (P) (*)

Surgical Summary

Surgical Summary

Vacc: Y N Pre Sx _____ Lab: Y N X-Rays: Y N

Procedure: _____

Induction: _____

Anesth: _____ / O₂ _____ Mont. Sys: _____

Ligature: _____ Linea: _____

Subcu: _____ Skin: _____

Notes: _____

V-AN495 White - 240 / Roll
4-3/4"W x 1-7/8"H (P) (*)

SURGICAL SUMMARY

Current Yes Pre-surgical Yes X-rays Yes
Vaccinations No Screen No

Pre-Anesthetic: _____ Time: _____

Method of Induction: _____ Intravenous/Mask/Tube

Anesthetic: _____ Time: _____

Vaporizer: _____ Open System: _____ Closed System: _____

Type of Monitoring: _____ Surgeon: _____

Surgical Observations: (Describe below) _____

V-AN323 White - 320 / Roll
4"W x 2"H (P) (*)

SURGICAL SUMMARY DATE: _____

NAME: _____ LAB: Y N

PROCEDURE: _____ X-RAYS: Y N

PRE-ANESTHESIA: _____

INDUCTION: _____

ANESTHESIA: _____ TIME: _____

MONITOR SYSTEM: _____

FLUIDS: _____

CLOSURE: MUSC: _____ PERITON: _____

SUBQ: _____ SKIN: _____

SURGICAL OBSERVATION: _____

SURGEON: _____ ASST: _____

V-AN638 White - 240 / Roll
4"W x 2-5/8"H (P) (*)

examination record labels

Annual Visit

ANNUAL VISIT Name _____ Date _____

DA2PL PARVO CORONA RAB FVRCP FeLV

HEARTWORM: Neg. Pos. FECAL: Round Hook

On Medication Yes No Whip Tape

Type _____ All Year Neg.

N A N A Rx _____

ENT TEETH

UG EYES

HL SKIN

GI LN

Comments: _____

Age _____ Wt. _____ Temp. _____ Food Type _____

V-AN450 White – 240 / Roll
4"W x 2-5/8"H (*) (P)

ANNUAL VISIT Name _____ Date _____

DHLPL PARVO CORONA RAB FVRCP FeLV

HEARTWORM: Neg. Pos. FECAL: Round Hook

On Medication Yes No Whip Tape

Type _____ All Year Neg.

N A N A Rx _____

ENT TEETH

UG EYES

HL SKIN

GI LN

Comments: _____

Age _____ Wt. _____ Temp. _____ Food Type _____

V-AN413 White – 240 / Roll
4"W x 2-5/8"H (*) (P)

ANNUAL VISIT

ANN. PHYSICAL _____ DA2PLPC _____ FVRCP _____

FECAL _____ CORONA _____ LEUKEMIA _____

FIL _____ PARVO _____ 6 _____ 12 _____

WEIGHT _____ BORDETELLA _____

TEMP _____ RABIES _____

GEN APP _____ NA MUS/SK _____ NA

RESPIR _____ NA GEN/UR _____ NA

EARS _____ NA DENTAL _____ NA

SKIN _____ NA CIRCULATORY _____ NA

G/I _____ NA EYES _____ NA

NEURO _____ NA LYMPH NODES _____ NA

V-AN429 White – 390 / Roll
2-1/2"W x 2-1/2"H (*) (P)

Physical Examination



PHYSICAL EXAMINATION

Normal <input type="checkbox"/> Abnormal <input type="checkbox"/>	(3) MUSCULO-SKELETAL <input type="checkbox"/> Normal <input type="checkbox"/> Abnormal <input type="checkbox"/> Not examined <input type="checkbox"/>	(4) CIRCULATORY <input type="checkbox"/> Normal <input type="checkbox"/> Abnormal <input type="checkbox"/> Not examined <input type="checkbox"/>
(5) RESPIRATORY <input type="checkbox"/> Normal <input type="checkbox"/> Abnormal <input type="checkbox"/> Not examined <input type="checkbox"/>	(6) DIGESTIVE <input type="checkbox"/> Normal <input type="checkbox"/> Abnormal <input type="checkbox"/> Not examined <input type="checkbox"/>	(7) GENITO-URINARY <input type="checkbox"/> Normal <input type="checkbox"/> Abnormal <input type="checkbox"/> Not examined <input type="checkbox"/>
(8) EYES <input type="checkbox"/> Normal <input type="checkbox"/> Abnormal <input type="checkbox"/> Not examined <input type="checkbox"/>	(9) EARS <input type="checkbox"/> Normal <input type="checkbox"/> Abnormal <input type="checkbox"/> Not examined <input type="checkbox"/>	(10) NEURAL SYSTEMS <input type="checkbox"/> Normal <input type="checkbox"/> Abnormal <input type="checkbox"/> Not examined <input type="checkbox"/>
(11) LYMPH NODES <input type="checkbox"/> Normal <input type="checkbox"/> Abnormal <input type="checkbox"/> Not examined <input type="checkbox"/>	(12) MUCOUS MEMBRANES <input type="checkbox"/> Normal <input type="checkbox"/> Abnormal <input type="checkbox"/> Not examined <input type="checkbox"/>	

DESCRIBE ABNORMAL (Use numbers above) T _____ P _____ R _____ Wt. _____

SCALE EST

V-AN319 White – 240 / Roll
4-3/4"W x 1-7/8"H (*) (P)

PHYSICAL EXAM CHECKLIST

1. BEHAVIORAL <input type="checkbox"/> Normal <input type="checkbox"/> Abnormal <input type="checkbox"/>	2. INTEGUMENTARY <input type="checkbox"/> Normal <input type="checkbox"/> Abnormal <input type="checkbox"/>	3. MUSCULOSKELETAL <input type="checkbox"/> Normal <input type="checkbox"/> Abnormal <input type="checkbox"/>	4. CARDIOPULMONARY <input type="checkbox"/> Normal <input type="checkbox"/> Abnormal <input type="checkbox"/>
5. ENTERIC <input type="checkbox"/> Normal <input type="checkbox"/> Abnormal <input type="checkbox"/>	6. ORO-DENTAL <input type="checkbox"/> Normal <input type="checkbox"/> Abnormal <input type="checkbox"/>	7. GENITO-URINARY <input type="checkbox"/> Normal <input type="checkbox"/> Abnormal <input type="checkbox"/>	8. OPHTHALMIC <input type="checkbox"/> Normal <input type="checkbox"/> Abnormal <input type="checkbox"/>
9. OTIC <input type="checkbox"/> Normal <input type="checkbox"/> Abnormal <input type="checkbox"/>	10. NEURO-ENDOCRINE <input type="checkbox"/> Normal <input type="checkbox"/> Abnormal <input type="checkbox"/>	11. HEPATO-PANCREATIC <input type="checkbox"/> Normal <input type="checkbox"/> Abnormal <input type="checkbox"/>	12. IMMUNO-HEMATOLOGIC <input type="checkbox"/> Normal <input type="checkbox"/> Abnormal <input type="checkbox"/>

T _____ P _____ R _____ Wt. _____ DIET: _____

OTHER: _____

V-AN494 White – 240 / Roll
4-3/4"W x 1-7/8"H (*) (P)

PHYSICAL EXAM CHECKLIST

NAME: _____ OWNER: _____

DIET: _____ VACCINATIONS: _____

FECAL: _____ HEARTWORM CHECK: _____

GENERAL APPEARANCE <input type="checkbox"/> NORM <input type="checkbox"/> ABNORM	INTEGUMENTARY <input type="checkbox"/> NORM <input type="checkbox"/> ABNORM	MUSCULO-SKELETAL <input type="checkbox"/> NORM <input type="checkbox"/> ABNORM	CIRCULATORY <input type="checkbox"/> NORM <input type="checkbox"/> ABNORM
RESPIRATORY <input type="checkbox"/> NORM <input type="checkbox"/> ABNORM	DIGESTIVE <input type="checkbox"/> NORM <input type="checkbox"/> ABNORM	GENITO URINARY <input type="checkbox"/> NORM <input type="checkbox"/> ABNORM	EYES <input type="checkbox"/> NORM <input type="checkbox"/> ABNORM
EARS <input type="checkbox"/> NORM <input type="checkbox"/> ABNORM	NEURAL SYSTEM <input type="checkbox"/> NORM <input type="checkbox"/> ABNORM	LYMPH NODES <input type="checkbox"/> NORM <input type="checkbox"/> ABNORM	MUCOUS MEMBRANES <input type="checkbox"/> NORM <input type="checkbox"/> ABNORM
		DENTAL <input type="checkbox"/> NORM <input type="checkbox"/> ABNORM	

BT _____ HR _____ RR _____ Wt. _____

V-AN407 White – 240 / Roll
4"W x 2-5/8"H (*) (R)

DERMATOLOGY

LESIONS (circle): _____ Photos

Macules Papules Pustules Vesicles

Crusts Excoriations Ulcers Scales

Pruitis Wheals Nodules Tumors ()

Lichenification Hyperpigmentation

Erythema Alopecia Hyperkeratosis

Fleas Lice Sarcoptes Demodex Ticks

Fungi: Woods _____ KOH _____ Culture _____

Bacteriology: _____

Direct Smear: _____

Biopsy: _____

Lab: Out _____ In _____

V-AN639 White/Blue Type – 240 / Roll
4"W x 2-5/8"H (*) (P)

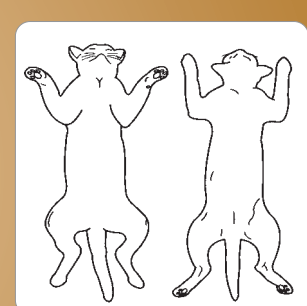

V-AN316 White – 320 / Roll
2-1/2"W x 2-1/2"H (*) (P)

OPHTHALMOLOGY	RIGHT	LEFT
EYE POSITION		
LIDS		
SCLERA		
CONJUNCTIVA		
TEARS		
LENS		
IRIS		
PUPIL		
RETINA		

V-AN649 White – 240 / Roll
4"W x 2-5/8"H (*) (P)

INITIAL EXAM

____ Eyes ____ ABD ____ Heart

____ Ears ____ Nodes ____ H Rate

____ Skin ____ Lungs ____ CRT

____ Hair Coat ____ Oral Exam

Note: _____

V-AN305 White – 320 / Roll
3"W x 2"H (*) (P)

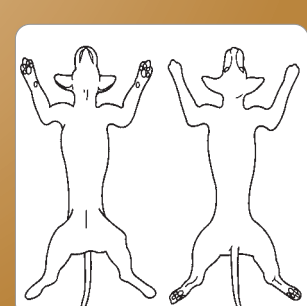

V-AN315 White – 320 / Roll
2-1/2"W x 2-1/2"H (*) (P)

laboratory labels

FeLV
+ _____ - _____
Date _____

V-AN268 Fl-Pink - 560 / Roll
1-5/8"W x 7/8"H (R) (*)

FECAL
Result: _____
Date: _____

V-AN607 Fl-Yellow - 560 / Roll
1-5/8"W x 7/8"H (P) (*)

F.I.V.
+ _____ - _____
Date _____

V-AN267 Fl-Orange - 560 / Roll
1-5/8"W x 7/8"H (R) (*)

Heartworm
+ _____ - _____
Date _____

V-AN295 Fl-Orange - 560 / Roll
1-5/8"W x 7/8"H (P) (*)

FECAL
+ _____ - _____

V-AN617 Fl-Green - 560 / Roll
1-5/8"W x 7/8"H (P) (*)

**PRE SURGICAL
LAB. WORK**
V-PS108 Fl-Pink - 760 / Roll
1-1/4"W x 5/16"H (P) (*)

FECAL
DIRECT _____
FLOTATION _____
Rx _____

V-AN203 Fl-Green - 420 / Roll
2-1/4"W x 7/8"H (R) (*)

PANEL: ALB _____ ALK _____ ALT _____
AMYL _____ Ca _____ CHOL _____
CREA _____ GLU _____ PHOS _____
TBIL _____ TP _____ BUN _____ GLOB _____

V-AN646 White/Blue Type - 420 / Roll
2-1/4"W x 7/8"H (P) (*)

Color _____ Sp. Gr. _____ pH _____
Protein _____ Glucose _____ Ketones _____
Bili _____ Blood _____ Urobil. _____
Micro _____

V-AN630 White/Blue Type - 420 / Roll
2-1/4"W x 7/8"H (P) (*)

HEARTWORM + _____ - _____
LYME + _____ - _____
EHRlichia + _____ - _____
DATE _____

V-AN296 Fl-Green - 420 / Roll
2-1/4"W x 7/8"H (P) (*)

BLOOD
WBC _____ RBC _____
SEG _____ HGB _____
Band _____ HCT _____
Lymph _____ Plat _____
MONO _____ TP _____
EOSIN _____
BASO _____

V-AN270 Fl-Pink - 420 / Roll
2-1/4"W x 7/8"H (P) (*)

NAME _____ DATE _____
Urine _____ BL _____ Bil _____
S.G. _____ pH _____ PR _____ UROB _____
KET _____ GLU _____
SED _____

V-AN627 White/Blue Type - 420 / Roll
2-1/4"W x 7/8"H (P) (*)

Urinalysis

URINALYSIS

Name: _____ Date: _____
Appearance: _____ Blood: _____
Color: _____ Bilirubin: _____
Protein: _____ Ketones: _____
Spec Grav: _____ Glucose: _____
Sediment: _____ Urobilinogen: _____
Bacteria: _____ RBC: _____
WBC: _____ Crystals: _____
Casts: _____ Epithelium: _____
pH: _____ Notes: _____

V-AN415 White - 240 / Roll 4"W x 2-5/8"H (P) (*)

URINALYSIS Name _____ Date _____
Method of Collection _____ Midstream Catch _____
Color: _____ Glucose _____ Ketones _____ pH _____
Appearance: _____ Spec. Grav.: _____ Protein: _____
Bile _____ Urobilinogen _____ Blood: _____
Other: _____
SEDIMENT: Casts: _____ WBC: _____
Epithelia: _____ RBC: _____ Bacteria: _____
Crystals: Type & # _____
Other _____
Interpretation: _____

V-AN436 White - 240 / Roll 4"W x 2-5/8"H (P) (*)

URINALYSIS
Breed _____ Age _____ Sex _____
Method of collection _____
Transparency _____ Sediment _____
Sp. Gr. _____ RBC _____ I/HPF _____
Color _____ WBC _____ I/HPF _____
PH _____ Cells _____ I/HPF _____
Protein _____ Casts _____ I/HPF _____
Glucose _____ Crystals _____ I/HPF _____
Ketones _____ Bacteria _____ I/HPF _____
Bili. _____ Sperm _____ I/HPF _____
Bld. _____
Urobil _____ Pet _____
Nitrites _____ Dr. _____

V-AN300 Fl-Yellow - 320 / Roll 3"W x 2"H (P) (*)

Pathology

PATHOLOGY SPEC.

NAME _____
DATE _____ SEX _____ AGE _____
ROOM _____ NUMBER _____
DOCTOR _____
SPECIMEN _____

V-LS120 White - 320 / Roll 3"W x 2"H (P) (*)

PATHOLOGY SPECIMEN

Name _____ Date _____
Specimen _____
Doctor _____



10% FORMALIN POISON

V-CL307 White - 320 / Roll 3"W x 2"H (P) (*)

PATHOLOGY SPECIMEN

V-LS401 White - 320 / Roll 3"W x 2"H (P) (*)

iv/medication added labels

Our detail-oriented **iv therapy labels** are essential to patient safety. Use them whenever IV medications are being administered to clearly communicate critical information. Intended for use on base labels only.

IV Therapy

**MEDICATION
ADDED TO I.V.**

Time	Date	By
Drug	Quantity	

Expires: Date _____ Time _____

V-HH207 FL-Red – 390 / Roll
2-1/2"W x 2-1/2"H (P)

**MEDICATION
ADDED TO I.V.**

PTS. NAME _____

ADDED BY _____

RETURN TO PHARMACY ON OR
BEFORE _____

V-HH502 FL-Red – 320 / Roll
2"W x 3"H (P)

CHEMOTHERAPY

V-HN119 FL-Pink – 760 / Roll
1-1/4"W x 5/16"H (R)

HEPARIN FLUSH

UNITS

V-IV111 FL-Red – 760 / Roll
1-1/4"W x 5/16"H (P)

STARTED:
DATE: _____
HOUR: _____
 ML/HR
 _____ GTTS/MIN

**HEPARIN
FLUSH**

V-IV213 FL-Red – 420 / Roll
2-1/4"W x 7/8"H (P)

CATHETER IN PLACE

Date _____ Time _____

Type _____

Size _____

V-SD131 FL-Yellow – 420 / Roll
2-1/4"W x 7/8"H (R)

CHEMOTHERAPY

WEAR GLOVES WHEN
CHANGING TUBING AND BAG

 DISPOSE OF PROPERLY

PRIME CAREFULLY INTO
PLASTIC BAG OR GAUZE PAD

V-ON301 FL-Pink – 320 / Roll
3"W x 2"H (R)

drug syringe labels

**HEPARINIZED
SALINE**

V-AM723 White – 760 / Roll
1-1/4"W x 5/16"H (P)

KETAMINE
Mg/cc

V-AM121 FL-Yellow – 760 / Roll
1-1/4"W x 5/16"H (P)

ATROPINE
mg/ml

V-AM750 FL-Green – 760 / Roll
1-1/4"W x 5/16"H (P)

BUTORPHANOL
_____ mg

V-AN467 FL-Yellow – 760 / Roll
1-1/4"W x 5/16"H (P)

DIAZEPAM
mg/ml

V-AM794 FL-Orange – 760 / Roll
1-1/4"W x 5/16"H (P)

ANTIBIOTIC
_____ mg

V-AN468 White – 760 / Roll
1-1/4"W x 5/16"H (P)

KETAMINE _____ mg
VALIUM _____ mg

V-AN455 FL-Red – 760 / Roll
1-1/4"W x 5/16"H (P)

**NORMAL
SALINE**

V-AM141 FL-Orange – 760 / Roll
1-1/4"W x 5/16"H (P)

MORPHINE
mg/ml

V-AM762 Lt. Blue – 760 / Roll
1-1/4"W x 5/16"H (P)

PROPOFOL
mg/ml

V-AM006 FL-Yellow – 760 / Roll
1-1/4"W x 5/16"H (P)

_____ CC

V-AN140 FL-Yellow – 760 / Roll
1-1/4"W x 5/16"H (P)

**STERILE
NORMAL SALINE**

V-FP239 FL-Orange – 760 / Roll
1-1/4"W x 5/16"H (P)

V-FS002 Lt. Blue – 110 / Roll
9/10"W x 9"H (P)
1,000ml. (any bag or bottle)

medication instruction labels

KEEP IN REFRIGERATOR

V-FP109 Blue – 500 / Roll
1-5/8"W x 3/8"H (P) (*)

**FOR VETERINARY USE ONLY
KEEP OUT OF CHILDREN'S REACH**

V-AN104 White/Red Type – 500 / Roll
1-5/8"W x 3/8"H (P) (*)

GIVE UNTIL GONE

V-AN111 Red – 500 / Roll
1-5/8"W x 3/8"H (P) (*)

**This prescription cannot be
refilled without bloodwork.**

V-AN150 White/Blue Type – 500 / Roll
1-5/8"W x 3/8"H (P) (*)

FOR THE EYE

V-AN657 Red – 500 / Roll
1-5/8"W x 3/8"H (P) (*)

GIVE WITH FOOD

V-AN119 White/Red Type – 500 / Roll
1-5/8"W x 3/8"H (P) (*)

FOR THE EAR

V-FP112 Blue – 500 / Roll
1-5/8"W x 3/8"H (P) (*)

**Refrigerate and Shake
Well Before Using**

V-FP704 White/Blue Type – 500 / Roll
1-5/8"W x 3/8"H (P) (*)

CAUTION: Failure to use and refill this medication may lead to fatal heartworm disease.

V-AN252 Fl.-Red – 560 / Roll
1-5/8"W x 7/8"H (P) (*)

WARNING: BEFORE HEARTWORM PREVENTION CAN BE STARTED YOUR PET MUST HAVE A CURRENT HEARTWORM TEST WITH NEGATIVE RESULTS

V-AN229 Fl.-Orange – 420 / Roll
2-1/4"W x 7/8"H (P) (*)

CAUTION: Dogs **MUST** be blood tested **EVERY YEAR** before using this medicine. Severe reaction can occur if dog has heartworm infection.

V-AN236 Fl.-Red – 560 / Roll
1-5/8"W x 7/8"H (P) (*)

Continue this medication **YEAR ROUND** and **REFILL** as necessary. **ANNUAL** heartworm testing is recommended.

V-AN636 Fl.-Green – 420 / Roll
2-1/4"W x 7/8"H (P) (*)

KEEP OUT OF CHILDREN'S REACH

V-AN001 Fl.-Red – 560 / Roll
1-5/8"W x 7/8"H (P) (*)

We recommend year-round treatment for effective flea control in this climate.

V-AN659 Fl.-Yellow – 420 / Roll
2-1/4"W x 7/8"H (P) (*)

SHAKE WELL BEFORE USING

V-FP110 Blue – 500 / Roll
1-5/8"W x 3/8"H (P) (*)

FOR REFILLS PLEASE PHONE AHEAD

V-FP700 White/Blue Type – 500 / Roll
1-5/8"W x 3/8"H (P) (*)

FOR THE EAR

V-AN656 Blue – 500 / Roll
1-5/8"W x 3/8"H (P) (*)

REFILL WHEN EMPTY

V-AN103 White/Red Type – 500 / Roll
1-5/8"W x 3/8"H (P) (*)

This prescription cannot be refilled without an exam.

V-AN124 White/Blue Type – 500 / Roll
1-5/8"W x 3/8"H (P) (*)

CAUTION: May Cause Drowsiness

V-AN123 Fl.-Pink – 500 / Roll
1-5/8"W x 3/8"H (P) (*)

Keep in Refrigerator DO NOT FREEZE

V-FP105 Blue – 500 / Roll
1-5/8"W x 3/8"H (P) (*)

EXTERNAL USE ONLY

V-AN121 Fl.-Yellow – 500 / Roll
1-5/8"W x 3/8"H (P) (*)

CAUTION
Failure to use and refill this medication may lead to fatal heartworm disease. Continue medication **YEAR ROUND**. **ANNUAL** heartworm testing is recommended.

V-AN643 Fl.-Red – 320 / Roll 3"W x 2"H (P) (*)

medication dispensing labels

Date: _____ Patient: _____

HEARTWORM Preventative _____

Give 1 Tablet once a month

_____ to _____

Caution: Dogs must have a blood test each spring.

KEEP OUT OF CHILDREN'S REACH

V-AN307 White – 320 / Roll 3"W x 2"H (R) (*)

Date: _____ Patient: _____

FLEA CONTROL: _____

Apply 1 tube once a month to skin:

_____ At back of neck

_____ Between shoulder blades

_____ Above the rump

Dr. _____

FOR VETERINARY USE ONLY

V-AN337 White – 320 / Roll 3"W x 2"H (R) (*)

Date: _____ Patient: _____

HEARTWORM Preventative _____

Give 1 Tablet once a month

_____ to _____

Caution: Pets must have a blood test before using this medication.

KEEP OUT OF CHILDREN'S REACH

V-AN350 White – 320 / Roll 3"W x 2"H (R) (*)

billing & collection labels

REGULAR MONTHLY PAYMENTS ARE NECESSARY TO KEEP THIS ACCOUNT CURRENT

V-HC208 Fl.-Yellow – 500 / Roll
1-5/8"W x 7/8"H (P)

Just a friendly reminder that your account is overdue. Won't you please mail your remittance?

MAP4220 Fl.-Green – 250 / Roll
1-1/2"W x 7/8"H (P)



WE HATE TO KEEP HOUNDING YOU, BUT YOUR BILL IS PAST DUE.

UL520 Fl.-Pink – 420 / Roll
2-1/4"W x 7/8"H (P)

WE ACCEPT MAJOR CREDIT CARDS

To pay with your credit card please complete:

Acct. No. _____

VISA _____ MasterCard _____ American Ex _____ Discover _____

Exp. Date _____ Signature _____

MAP5790 Fl.-Chartreuse – 250 / Roll
3"W x 1"H (P)

FINAL NOTICE

This is the last statement that will be sent to you. Unless paid at once the account will be turned over for collection.

UL1402 Fl.-Orange – 320 / Roll
3"W x 7/8"H (P)

made-to-order dividers

CUSTOM INDEX:

Easy Ordering Instructions:

1. Specify paper weight and divider color:
 - 90 lb. or 110 lb.
 - White or Ivory (Manila) Stock
2. Choose tab print style and punch hole positions:
 - Side or Bottom Tabs
 - 5, 3, or 2 hole punch
3. Specify tab cut size (see charts) and tab extension
4. List tab titles, positions, and colors
5. Choose packaging options:
 - Collated / titles boxed together in sets
 - Non-Collated / each title boxed individually



SAVE TIME & MONEY BY HAVING US INSTALL DIVIDERS TO YOUR FILE FOLDERS

- ◆ 90 lb. or 110 lb. White or Ivory Stock
- ◆ Side or Bottom indexing
- ◆ Reinforced 5, 3 or 2 hole punch
- ◆ Mylar[®] reinforced tabs printed on one or two sides
- ◆ Available tab extensions: 1/4", 3/8" or 1/2"
- ◆ Available in pre-collated sets or individual tab sheets
- ◆ Black printing on body copy available

CUSTOM FILEBACK:

Easy Ordering Instructions:

1. Specify Side or Bottom tabs
2. Choose Fastener: Top or Side
3. Specify Style: Hinge or Self-Adhesive
4. List tab titles, positions, and colors
5. Choose packaging options:
 - Collated / titles boxed together in sets
 - Non-Collated / each title boxed individually



- ◆ 110 lb. Ivory Stock
- ◆ Side or Bottom indexing
- ◆ 2" Heat Bonded Fastener
- ◆ Scored hinge with Mylar[®] reinforced slots or self-adhesive transfer tape
- ◆ Mylar[®] reinforced tabs printed on one or two sides
- ◆ Available tab extensions: 1/2" or 3/8"
- ◆ Available in pre-collated sets or individual tab sheets
- ◆ Black printing on body copy available

file folders

Manila **file folders** with or without fasteners. 12-1/4"W x 9-1/2"H overall size

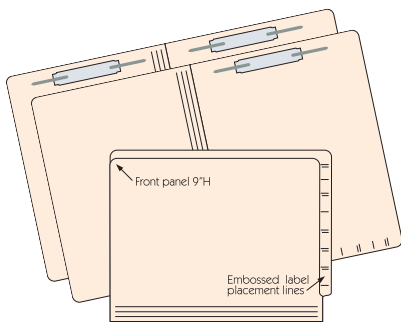

11 PT. 2-Ply Letter

stock no.	fastener position(s)	folders/case
56012	-	500
560121	1	250
5601213	1 & 3	250

14 PT. 1-Ply Letter

56015	-	500
560151	1	250
5601513	1 & 3	250

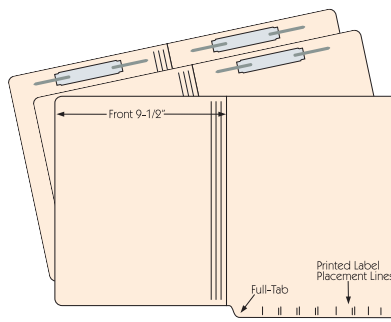

11 PT. 2-Ply Letter

stock no.	fastener position(s)	folders/case
56018	-	500
560181	1	250
5601813	1 & 3	250

14 PT. 1-Ply Letter

56019	-	500
560191	1	250
5601913	1 & 3	250

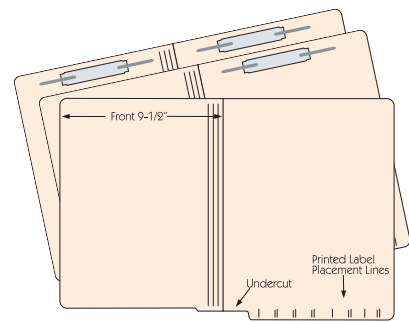

11 PT. 2-Ply Letter

stock no.	fastener position(s)	folders/case
56022	-	500
56023	1	250
56024	1 & 3	250

14 PT. 1-Ply Letter

56025	-	500
560251	1	250
5602513	1 & 3	250

combination drawer/shelf file folders

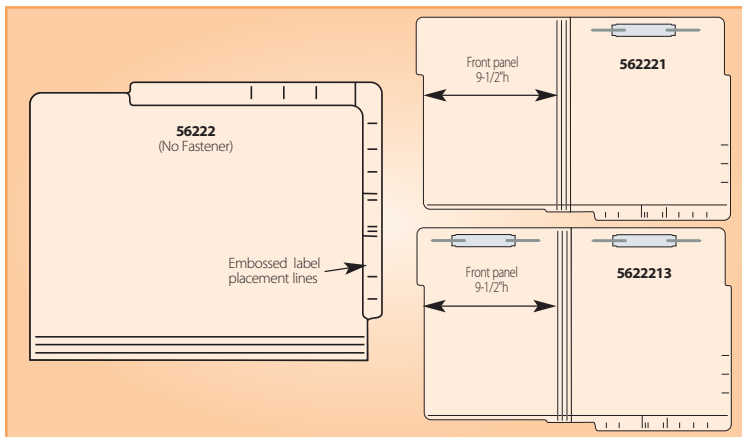

11 pt. 2-Ply (Reinforced) Letter

Manila **combination drawer / shelf file folder** design can be used as top tab in a drawer or as an end tab in an open shelf. Large tab area on top and side allows plenty of room for all your labeling needs. Available with or without fasteners. 12"W x 9-1/2"H overall size.

stock no.	fastener position(s)	folders/case
56222	-	500
562221	1	250
5622213	1 & 3	250

self-adhesive divider sheets

8-1/2"W x 11"H (not including flap)

Quickly divide the contents of your folders with our easy to install **self-adhesive divider sheets**.

Dividers are 11 pt. manila stock. Die-cuts on flap allow for easy positioning around fasteners.

100 dividers per package.

stock no.	fastener position(s)
26330	None
263301	1-Fastener Front Top – Pos. #1
263305	1-Fastener Front Top – Pos. #5
2633013	2-Fasteners Top two sides – Pos. #1 & #3



file folder fasteners

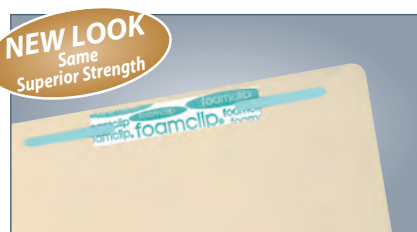

Self-adhesive **foamclip® fasteners** are a perfect choice for organizing any 2-hole punched papers. These fasteners bond permanently to file folders, pressboard, plastic, wood, glass, even metal. With their superior strength, **foamclip® fasteners** can't be pulled off like other brands! The 2-3/4" center-to-center, 1-1/2" capacity fastener is easy to use; just peel off backing paper and press fastener into place.

stock no.	description	fasteners/box
56807	foamclip fasteners	100



duo-prong fasteners are used when fasteners are required on both the front and back of a divider sheet for 2-hole punched documents. Fastener capacity is 1" on one side and 5/8" on the other. Simply insert 1" prongs thru slits in divider sheet, and bend prongs back. No adhesive required.

stock no.	description	fasteners/box
26808	duo-prong fasteners	100



Self-adhesive **sup'r'grip fasteners** are an ideal space-saving solution for large files. Long 2" prongs accommodate 2-hole punched material, while the ultra-thin design saves valuable filing space. Fasteners are heat bonded onto pressure-sensitive, 60 lb. manila-colored paper to hold even the bulkiest files without tearing. Printed aligning guides on each strip ensure accurate placement. 4 fasteners per sheet; 25 sheets per box.

stock no.	description	fasteners/box
56805	sup'r'grip fasteners	100

lock-it pockets



Peel off self-adhesive 5 mil **lock-it pocket**. Permanently apply to your folders or wherever it is most convenient. Durable, clear polyethylene ziplock style secures small documents, including photos, diskettes, CD's, x-rays and much more. Clear front keeps important information at full view without opening the pocket.

stock no.	inside	outside	pockets/box
54470	5"w x 5-1/4"h	5-1/2"w x 6-1/4"h	100
54471	6"w x 9"h	6-1/2"w x 10"h	100

First dimension is the pocket opening

poly & vinyl pockets

Clear see-thru pockets are available in several sizes to fit all your needs. It's easy to add a pocket to your file or binder; simply peel off the protective backing and apply the self-adhesive side to your folder. Pockets are sealed on three sides. Store x-rays, forms, immunization records, computer diskettes, CD's and more.

POLY POCKETS provide easy access to information.

stock no.	inside	outside	pockets/box
54495	2-1/2"w x 3-1/4"h	3"w x 3-3/4"h	100
54496	10-1/2"w x 8-1/2"h	11"w x 9"h	100
54497	5"w x 3"h	5-3/4"w x 3-3/4"h	100
54498	6-1/2"w x 4-1/4"h	7"w x 4-3/4"h	100
54499	8-3/4"w x 5-1/2"h	9-1/4"w x 6"h	100

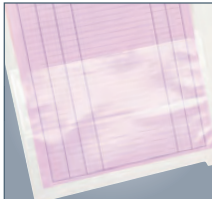

VINYL POCKETS are textured and heavy-duty.

stock no.	inside	outside	pockets/box
54492	8-3/4"w x 11-1/4"h	9"w x 11-1/2"h	100
54493	5-1/4"w x 3-1/4"h	5-1/2"w x 3-1/2"h	100
54494	8-3/4"w x 5-1/2"h	9"w x 5-3/4"h	100

First dimension is the pocket opening



cov'r'tabs

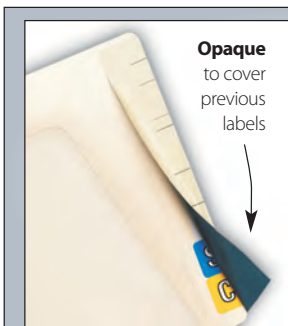

Opaque to cover previous labels

- ◆ Easy way to re-use old folders.
- ◆ Self-adhesive and wrap-around design adds reinforcement to tab.
- ◆ Printed score marks for even positioning of new labels.
- ◆ 60 lb. in manila color finish.
- ◆ Strip must be applied to folder "before" application of new labels.

stock no.	size	cov'r'tabs/pkg.
55990	2-1/2"w x 8"h	50

file folder label protectors



End Tab

file folder label protectors eliminate dirty, worn, dog-eared file folders and file folder labels. Clear, wrap-around, self-adhesive protectors keep file folders and labels clean and prevent them from falling off, extending the life of the folder. Name label protectors can also be used "flat" to attach miscellaneous materials to any surface.



Top Tab

stock no.	size	protectors/pkg.	pkgs./box	protectors/roll
58385	3-1/2"w x 2"h	100	5	-
58485	4"w x 2"h	100	5	-
58385B	3-1/2"w x 1-3/4"h	-	500*	-
88385	3-1/2"w x 2"h	-	-	500
88485	4"w x 2"h	-	-	500

*500 single protectors per box

full end tab protectors



end tab protectors are an ideal solution for extending the life of shelf file folders. Clear protectors wrap around folder end tabs, preventing labels from cracking or popping off, and protect against wear and tear. Self-adhesive, 8" x 2" protectors can be easily applied to all types of end tab file folders to keep them looking neat and clean longer.

stock no.	size	protectors/pkg.
68386	8"h x 2"w	100

spine edge protectors



spine edge protectors keep heavily used file folders looking good longer by protecting edges from cracking or splitting. The 11" x 2" clear, wrap-around protector is easily applied to the bottom edge of a file folder, where the most wear and tear occurs as the folder is moved in and out of shelf file cabinets.

stock no.	size	protectors/pkg.
68387	11"w x 2"h	100

color code labels



Original Col'R'Tab® series
 1"H x 1-1/2"W (P) (L)
Roll Unit – 42000 (28 rolls)
Desktop Kit –
 32000 (3,200 labels)

500/Roll 100/Pkg.

12001 – Roll 82001 – Pkg.	12002 – Roll 82002 – Pkg.	12003 – Roll 82003 – Pkg.	12004 – Roll 82004 – Pkg.	12005 – Roll 82005 – Pkg.	12006 – Roll 82006 – Pkg.	12007 – Roll 82007 – Pkg.
12008 – Roll 82008 – Pkg.	12009 – Roll 82009 – Pkg.	12010 – Roll 82010 – Pkg.	12011 – Roll 82011 – Pkg.	12012 – Roll 82012 – Pkg.	12013 – Roll 82013 – Pkg.	12014 – Roll 82014 – Pkg.
12015 – Roll 82015 – Pkg.	12016 – Roll 82016 – Pkg.	12017 – Roll 82017 – Pkg.	12018 – Roll 82018 – Pkg.	12019 – Roll 82019 – Pkg.	12020 – Roll 82020 – Pkg.	12021 – Roll 82021 – Pkg.
12022 – Roll 82022 – Pkg.	12023 – Roll 82023 – Pkg.	12024 – Roll 82024 – Pkg.	12025 – Roll 82025 – Pkg.	12026 – Roll 82026 – Pkg.	12027 – Roll 82027 – Pkg.	



Colwell Jewel-Tone compatible series
 1"H x 1-1/2"W (P) (L)
Roll Unit –
 91420 (28 rolls)



500/Roll 240/Ringbook Pkg.

91421 – Roll 61421 – Ring	91422 – Roll 61422 – Ring	91423 – Roll 61423 – Ring	91424 – Roll 61424 – Ring	91425 – Roll 61425 – Ring	91426 – Roll 61426 – Ring	91427 – Roll 61427 – Ring
91428 – Roll 61428 – Ring	91429 – Roll 61429 – Ring	91430 – Roll 61430 – Ring	91431 – Roll 61431 – Ring	91432 – Roll 61432 – Ring	91433 – Roll 61433 – Ring	91434 – Roll 61434 – Ring
91435 – Roll 61435 – Ring	91436 – Roll 61436 – Ring	91437 – Roll 61437 – Ring	91438 – Roll 61438 – Ring	91439 – Roll 61439 – Ring	91440 – Roll 61440 – Ring	91441 – Roll 61441 – Ring
91442 – Roll 61442 – Ring	91443 – Roll 61443 – Ring	91444 – Roll 61444 – Ring	91445 – Roll 61445 – Ring	91446 – Roll 61446 – Ring	91447 – Roll 61447 – Ring	

(*) = Image Not Actual Size / (P) = Permanent / (R) = Removable / (L) = Laminated
 Due to catalog printing processes, colors may vary slightly on product from color illustrated.

color code labels

A A 91521 — Roll 71521 — Pkg. 61521 — Ring	B B 91522 — Roll 71522 — Pkg. 61522 — Ring	C C 91523 — Roll 71523 — Pkg. 61523 — Ring	D D 91524 — Roll 71524 — Pkg. 61524 — Ring	E E 91525 — Roll 71525 — Pkg. 61525 — Ring	F F 91526 — Roll 71526 — Pkg. 61526 — Ring	G G 91527 — Roll 71527 — Pkg. 61527 — Ring
H H 91528 — Roll 71528 — Pkg. 61528 — Ring	I I 91529 — Roll 71529 — Pkg. 61529 — Ring	J J 91530 — Roll 71530 — Pkg. 61530 — Ring	K K 91531 — Roll 71531 — Pkg. 61531 — Ring	L L 91532 — Roll 71532 — Pkg. 61532 — Ring	M M 91533 — Roll 71533 — Pkg. 61533 — Ring	N N 91534 — Roll 71534 — Pkg. 61534 — Ring
O O 91535 — Roll 71535 — Pkg. 61535 — Ring	P P 91536 — Roll 71536 — Pkg. 61536 — Ring	Q Q 91537 — Roll 71537 — Pkg. 61537 — Ring	R R 91538 — Roll 71538 — Pkg. 61538 — Ring	S S 91539 — Roll 71539 — Pkg. 61539 — Ring	T T 91540 — Roll 71540 — Pkg. 61540 — Ring	U U 91541 — Roll 71541 — Pkg. 61541 — Ring
V V 91542 — Roll 71542 — Pkg. 61542 — Ring	W W 91543 — Roll 71543 — Pkg. 61543 — Ring	X X 91544 — Roll 71544 — Pkg. 61544 — Ring	Y Y 91545 — Roll 71545 — Pkg. 61545 — Ring	Z Z 91546 — Roll 71546 — Pkg. 61546 — Ring	MC MC 91547 — Roll 71547 — Pkg. 61547 — Ring	FF FF 91563 — Roll 71563 — Pkg. 61563 — Ring



Jeter[®] 5800, 7100, 7200 compatible series
15/16"H x 1-5/8"W (P)
Roll Unit - 91520 (28 rolls)

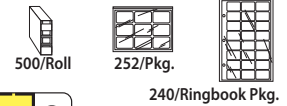

Jeter[®] 0200 compatible series
15/16"H x 1-5/8"W (P) (L)
240/Ringbook Pkg.

A A 91721 — Roll 61721 — Ring	B B 91722 — Roll 61722 — Ring	C C 91723 — Roll 61723 — Ring
D D 91724 — Roll 61724 — Ring	E E 91725 — Roll 61725 — Ring	F F 91726 — Roll 61726 — Ring
G G 91727 — Roll 61727 — Ring	H H 91728 — Roll 61728 — Ring	I I 91729 — Roll 61729 — Ring
J J 91730 — Roll 61730 — Ring	K K 91731 — Roll 61731 — Ring	L L 91732 — Roll 61732 — Ring
M M 91733 — Roll 61733 — Ring	N N 91734 — Roll 61734 — Ring	O O 91735 — Roll 61735 — Ring
P P 91736 — Roll 61736 — Ring	Q Q 91737 — Roll 61737 — Ring	R R 91738 — Roll 61738 — Ring
S S 91739 — Roll 61739 — Ring	T T 91740 — Roll 61740 — Ring	U U 91741 — Roll 61741 — Ring
V V 91742 — Roll 61742 — Ring	W W 91743 — Roll 61743 — Ring	X X 91744 — Roll 61744 — Ring
Y Y 91745 — Roll 61745 — Ring	Z Z 91746 — Roll 61746 — Ring	MC MC 91747 — Roll 61747 — Ring



Barkley[®] ABKM compatible series
1"H x 1-1/2"W (P) (L)
Roll Unit - 31620 (28 rolls)
Desktop Kit - 71620 (2,016 labels)

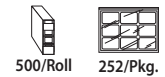

A A 91621 — Roll 71621 — Pkg.	B B 91622 — Roll 71622 — Pkg.	C C 91623 — Roll 71623 — Pkg.	D D 91624 — Roll 71624 — Pkg.	E E 91625 — Roll 71625 — Pkg.
F F 91626 — Roll 71626 — Pkg.	G G 91627 — Roll 71627 — Pkg.	H H 91628 — Roll 71628 — Pkg.	I I 91629 — Roll 71629 — Pkg.	J J 91630 — Roll 71630 — Pkg.
K K 91631 — Roll 71631 — Pkg.	L L 91632 — Roll 71632 — Pkg.	M M 91633 — Roll 71633 — Pkg.	N N 91634 — Roll 71634 — Pkg.	O O 91635 — Roll 71635 — Pkg.
P P 91636 — Roll 71636 — Pkg.	Q Q 91637 — Roll 71637 — Pkg.	R R 91638 — Roll 71638 — Pkg.	S S 91639 — Roll 71639 — Pkg.	T T 91640 — Roll 71640 — Pkg.
U U 91641 — Roll 71641 — Pkg.	V V 91642 — Roll 71642 — Pkg.	W W 91643 — Roll 71643 — Pkg.	X X 91644 — Roll 71644 — Pkg.	Y Y 91645 — Roll 71645 — Pkg.
Z Z 91646 — Roll 71646 — Pkg.	MC MC 91647 — Roll 71647 — Pkg.			

color code labels

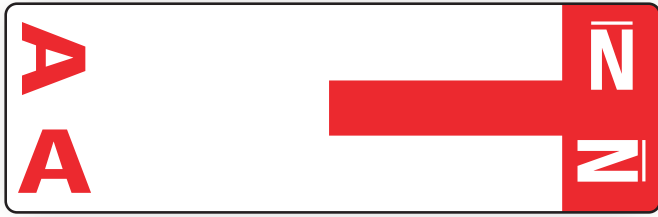

Smead® NCC compatible series

1-5/32"H x 3-5/8"W (P)

Desktop Kit -

31920 (1,500 labels)



100/Pkg.

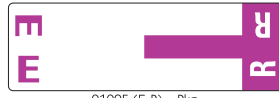

91925 (E-R) - Pkg.

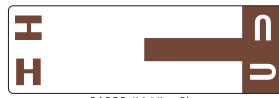

91928 (H-U) - Pkg.

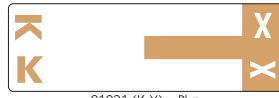

91931 (K-X) - Pkg.

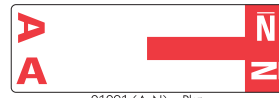

91921 (A-N) - Pkg.

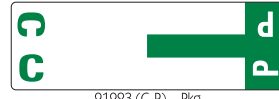

91923 (C-P) - Pkg.

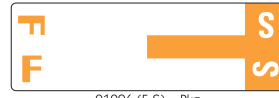

91926 (F-S) - Pkg.

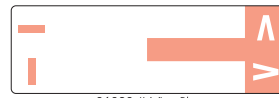

91929 (I-V) - Pkg.

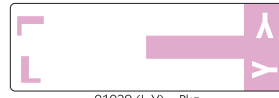

91932 (L-Y) - Pkg.

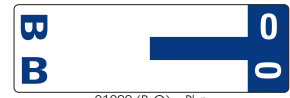

91922 (B-O) - Pkg.

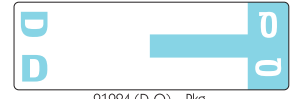

91924 (D-Q) - Pkg.



91927 (G-T) - Pkg.

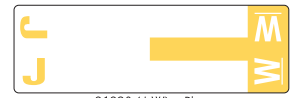

91930 (J-W) - Pkg.

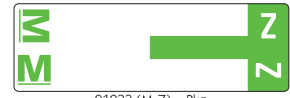

91933 (M-Z) - Pkg.

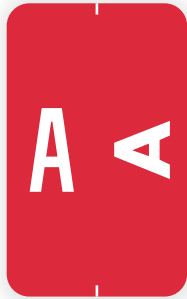

Smead® ACC & ACCS compatible series

1-5/8"H x 1"W (P) (L)

Roll Unit - 41820 (26 rolls)



250/Roll 108/Pkg.



Smead® BCCS & BCCR compatible series

1"H x 1-1/4"W (P) (L)

Roll Unit - 41020 (28 rolls)



500/Roll 240/Pkg.

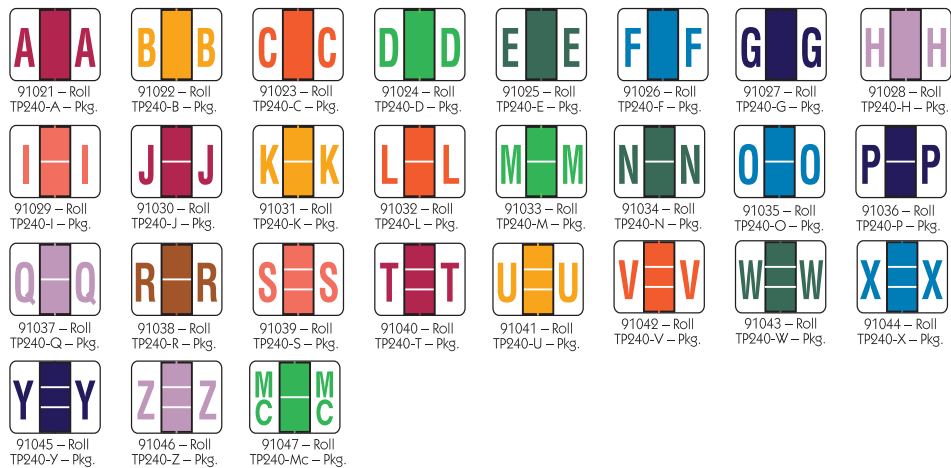

color code labels

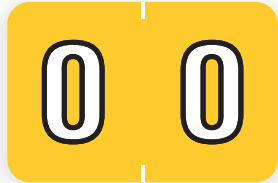

Colwell® Jewel-Tone compatible series
1"H x 1-1/2"W (P)
Roll Unit - 91410 (28 rolls)



500/Roll



Barkley® NBKM compatible series
1"H x 1-1/2"W (P) (L)
Roll Unit - 31600 (10 rolls)



500/Roll

252/Pkg.

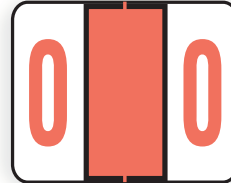

Smead® BCCRN compatible series
1"H x 1-1/4"W (P) (L)
Roll Unit - (10 rolls)
71010 (Kimdura)/91010 (Laminated)

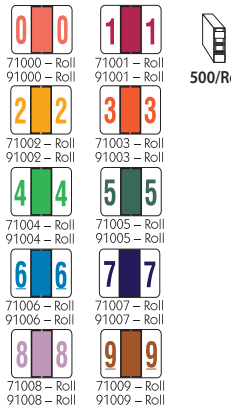

500/Roll

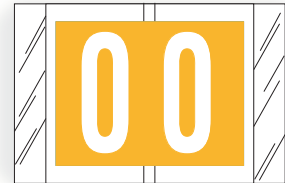

Original Col'RTab® series
1"H x 1-1/2"W (P) (L)
Roll Unit - 41000 (10 rolls)

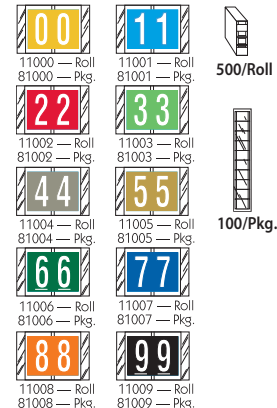

500/Roll

100/Pkg.



Smead® LCC compatible series
2"H x 1"W (P) (L)
Roll Unit - 41800 (10 rolls)

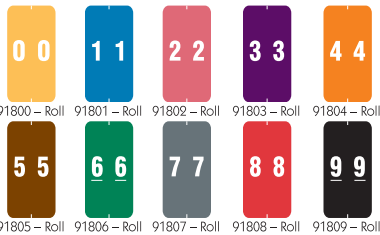

250/Roll



Jeter® 7300 compatible series
15/16"H x 1-5/8"W (P) (L)

500/Roll 252/Pkg.

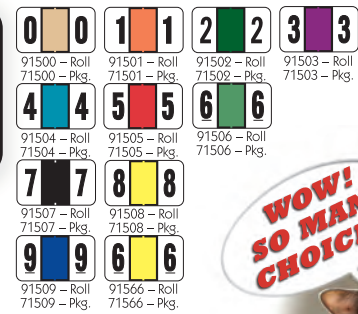

Additional ALPHABETIC, NUMERIC, MONTHLY & DESIGNATOR LABELS

ALPHABETIC (*) (P) (L)

Col'RTab® original series
81950 - 100/Pkg.

Alpha-Kolor™ series Col'RTab® original
14800 - 500/Roll

Col'RTab® original series
82050 - 100/Pkg.

POS® compatible series
62230 - 150/Ringbook Pkg.

POS® 2000 compatible series
62240 - 240/Ringbook Pkg.

Safeguard® compatible series
93020 - 500/Roll
63020 - 240/Ringbook Pkg.

Tab Products® compatible series
14100 - 500/Roll
84100 - 100/Pkg.

Tab Products® Jeter® 5100 compatible series
91120 - 500/Roll
71120 - 252/Pkg.

Tab Products® compatible series
71220 - 500/Roll

GBS®/VRE compatible series
91320 - 550/Roll
61320 - 200/Ringbook Pkg.

Tabbies® original series
90120 - 500/Roll
70120 - 252/Pkg.

MONTHLY (*) (P) (L)

Tabbies® original series
70230 - 100/Pkg.

Col'RTab® original series
11880 - 100/Pkg.

NUMERIC (*) (P) (L)

Ames® compatible series
94900 - 500/Roll

Col'RTab® original series
11500 - 500/Roll
81500 - 100/Pkg.

Col'RTab® original series
11050 - 500/Roll

DigiKolor® series Col'RTab® original
14560 - 500/Roll

DigiKolor® series Col'RTab® original
14570 - 500/Roll

Tabbies® original series
90100 - 500/Roll
70100 - 252/Pkg.

GBS®/VRE compatible series
91300 - 550/Roll

Tab Products® compatible series
14000 - 500/Roll

Tab Products® compatible series
91100 - 500/Roll
71100 - 252/Pkg.

DESIGNATOR (*) (P) (L)

Tabbies® original series
70520 - 252/Pkg.

Jeter® 9500 compatible series
91980 - 500/Roll

Col'RTab® original series
11600 - 500/Roll

Col'RTab® original series
11100 - 500/Roll
81100 - 100/Pkg.

year code labels

Acme Visible® compatible series
3/4"H x 1-1/2"W • 1,000 / Roll (*) (P) (L)

Ames® compatible series
1-7/8"H x 1-7/8"W • 500 / Roll (*) (P) (L)

Authorization On File
5/16"H x 1-1/4"W • 500 / Roll (*) (P) (L)

Barkley® compatible series
3/4"H x 1-1/2"W • 500 / Roll (*) (P) (L)

Colwell® compatible series
3/4"H x 1-1/2"W • 500 / Roll (*) (P) (L)

Digi-Kolor® series (original Col'RTab®)
3/4"H x 1-1/2"W • 1,000 / Roll (*) (P) (L)

GBS®/VRE® compatible series
3/4"H x 1-1/2"W • 500 / Roll (*) (P) (L)

Jeter® compatible series
3/4"H x 1-1/2"W • 500 / Roll (*) (P) (L)

Jeter® compatible series
3/4"H x 1-1/2"W • 500 / Roll (*) (P) (L)

Medical Arts Press® compatible series
3/4"H x 1-1/2"W • 500 / Roll (*) (P) (L)



Col'RTab® original series
3/4"H x 1-1/2"W (*) (P) (L)
11713, 11714, 11715 - 1,000 / Roll
51713, 51714, 51715 - 500 / Roll
81713, 81714, 81715 - 250 / Pkg.

Col'RTab® original series
1-1/2"H x 3/4"W • 1,000 / Roll (*) (P) (L)

Tabbies® original series
3/4"H x 1-1/2"W • 500 / Roll (*) (P) (L)

Tabbies® original series
1"H x 1/2"W • 250 / Pkg. (*) (P) (L)

SFI® compatible series
3/4"H x 1-1/2"W • 1,000 / Roll (*) (P) (L)

Smead®/Jeter® compatible series
3/4"H x 1-1/2"W • 500 / Roll (*) (P) (L)

Smead® compatible series
1/2"H x 1"W (*) (P) (L)

Smead® compatible series
1"H x 1/2"W • 500 / Roll (*) (P) (L)

Tab Products® compatible series
3/4"H x 1-1/2"W • 500 / Roll (*) (P) (L)

Tab Products® compatible series
1/2"H x 1-1/8"W • 500 / Roll (*) (P) Kimdura

laser/inkjet file folder labels

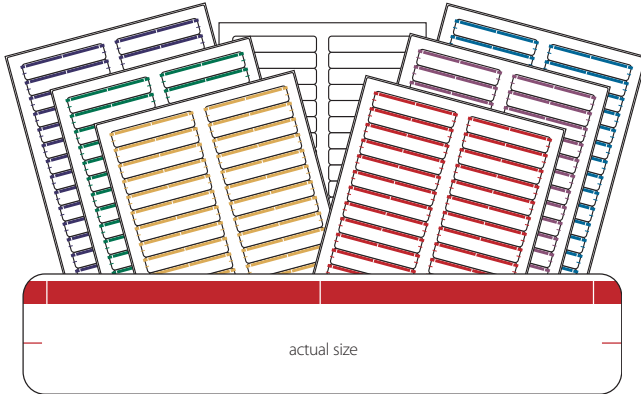

laser / inkjet file folder labels are easy to use with most label software. The paper and adhesive are formulated specifically for use in laser or inkjet printers. 750 labels per package. Labels are 2-up per page.

Overall sheet size: 8-1/2" w x 11" h. Label size: 3-7/16" w x 2/3" h – Color bar or White. Compatible to Avery Labels #5366

stock no.	color	labels/sheet	sheets/pkg.
49430	White	30	25
49431	Light Blue	30	25
49432	Red	30	25
49436	Green	30	25
49437	Dark Blue	30	25
49441	Tan	30	25
49443	Purple	30	25

laser/inkjet label sheets

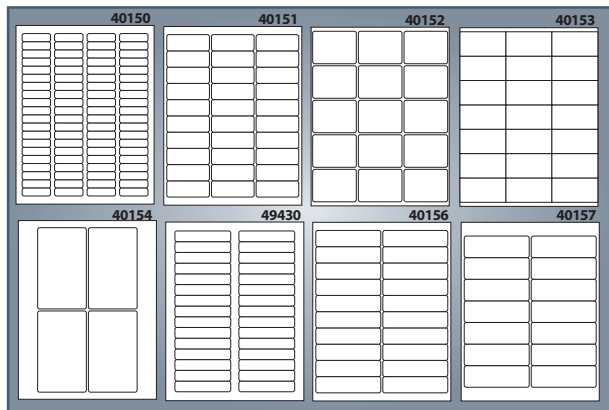

Multi-use **laser/inkjet label sheets** are useful for mailings, announcements, getting organized, tracking or recalling documents in legal proceedings and more. Labels are easy to apply for convenient, personalized labels anytime. Sheets are shrink-wrapped in packages and are fully compatible with both laser and inkjet printers. Labels feed automatically from paper tray and are centered on sheets so they can be fed using either the top or bottom as the lead edge. See your printer manual for additional feeding instructions.

stock no.	label size	labels/sheet	Avery® match	total labels
40150	1-3/4" x 1/2"	80	5167	8,000
40151	2-5/8" x 1"	30	5160	3,000
40152	2-11/16" x 2"	15	6490	1,500
40153	2-13/16" x 1-1/2"	21	–	2,100
40154	3" x 5"	4	–	400
49430	3-7/16" x 2/3"	30	5366	750
40156	4" x 1"	20	5161	2,000
40157	4" x 1-1/3"	14	5162	1,400

labels-u-create



Create bright, eye-catching communication labels in seconds, using your PC and laser printer with **labels-u-create** to make custom labels for any application. Permanent labels can be applied to folders, documents, drawers, even shelving. Make an entire sheet of the same label or just a few at a time. Easy set-up instructions inside. Works with Microsoft Word®. No additional software is needed. 10 (8-1/2"x11") sheets per package. See below for available colors and sizes.

stock no.	label size	color	labels/sheet	labels/pkg.	stock no.	label size	color	labels/sheet	labels/pkg.
40100	1-1/2" X 7/8"	White	32	320	40122	1-1/2" X 1-1/2"	Fl-Green	20	200
40101	1-1/2" X 7/8"	Fl-Red	32	320	40123	1-1/2" X 1-1/2"	Fl-Yellow	20	200
40102	1-1/2" X 7/8"	Fl-Green	32	320	40140	3-1/4" X 1-3/4"	White	10	100
40103	1-1/2" X 7/8"	Fl-Yellow	32	320	40141	3-1/4" X 1-3/4"	Fl-Red	10	100
40120	1-1/2" X 1-1/2"	White	20	200	40142	3-1/4" X 1-3/4"	Fl-Green	10	100
40121	1-1/2" X 1-1/2"	Fl-Red	20	200	40143	3-1/4" X 1-3/4"	Fl-Yellow	10	100

erasable write-on index tabs



erasable write-on index tabs can be used over and over again. Write with pencil or any erasable ink pen – then just erase and reuse. Tabs have 1/2" tab extension with colored edges. Ideal for any filing, flagging or indexing situation.

stock no.	tab size	color edge	tabs/pkg.	pkgs./box	stock no.	tab size	color edge	tabs/pkg.	pkgs./box
58700	1-1/2"	Yellow	16	10	58707	1-1/2"	Blue	16	10
58702	1-1/2"	Red	16	10	58709	1-1/2"	Black	16	10
58706	1-1/2"	Green	16	10	58710	1-1/2"	White	16	10

INDEX

Animal Alert Cards2
 Cage Cards2
 Custom Index Dividers11
 Fasteners – File Folders12
 File Folders11-12
 Marketing & Client Giveaways2

 Medical Records4
 Pockets – File13
 Self-Adhesive Dividers12

LABELS
 Allergy Warning4
 Alphabetic14-17
 Annual Visit7
 Authorization & Consent5
 Billing & Collection10
 Care Instructions2-3
 Cov’RTabs13
 Dental Examination Records6
 Designator17
 Drug Syringe9
 Erasable Write-on Index Tabs19
 Examination Records6-7
 Inventory Control & Sterilization4
 IV/Medication Added9
 Labels-U-Create19

LABELS (cont.)
 Laboratory8
 Laser/Inkjet19
 Medication Dispensing10
 Medication Instruction10
 Monthly17
 Name19
 Numeric17
 Pathology8
 Physical Examination7
 Protectors – File Folder13
 Surgical Summary6
 Urinalysis8
 Vaccination Records4
 X-Ray5
 Year Code Labels18



OTHER CATALOGS AVAILABLE:

- Filing, Indexing & Labeling Products
- Healthcare Filing, Indexing & Labeling Products
- Legal Filing, Indexing & Labeling Products
- Religious Products