



**NO KNOWN ALLERGIES**

**OWN FOOD**

**SURGERY DO NOT FEED OR WATER TODAY**

**WILL BITE**

**GIVE WITH FOOD**

**BATH**

**MEDICATION ADDED TO I.V.**

**tabbies®**

# Veterinary Filing, Indexing & Labeling Products Catalog

simple solutions @ work®



## animal alert cards

**MARKETING & CLIENT GIVEAWAYS**



**Front Side**

**ANIMAL ALERT CARD**  
Pets needing attention:

DOG \_\_\_\_\_  
 CAT \_\_\_\_\_  
 BIRD \_\_\_\_\_  
 OTHER \_\_\_\_\_

**Back Side**

**ANIMAL ALERT CARD**  
If I am ill or injured and unable to care for my pets, please call:

CONTACT NAME \_\_\_\_\_  
 ADDRESS \_\_\_\_\_  
 HOME PHONE \_\_\_\_\_ CELL \_\_\_\_\_  
 OWNER NAME \_\_\_\_\_  
 In case of emergency or if above contact cannot be located, call:  
 VET NAME \_\_\_\_\_  
 VET ADDRESS \_\_\_\_\_  
 VET PHONE \_\_\_\_\_

Stock No. 54661  
U.S. Patent No. 8,383,222  
**Stock #54661**

**animal alert card** is self-laminating to seal in the written information. Folds to the size of a credit card and is perfect as a giveaway for: Veterinary Offices, Kennel Clubs, Animal Associations, Pet Stores, and much more...

---

**54661** Animal Alert Card – 25 / pkg  
3-3/8"Wx2-1/8"H

---

**34661** Animal Alert Card 150 Card/Display  
3-1/8"Dx2-3/4"Wx9-1/8"H

---

**AMLDS** Animal Alert Card Acrylic Display  
w/label and placard only  
3-1/8"Dx2-3/4"Wx9-1/8"H

**ANIMAL ALERT CARD**  
Pets needing attention:

DOG \_\_\_\_\_  
 CAT \_\_\_\_\_  
 BIRD \_\_\_\_\_  
 OTHER \_\_\_\_\_

SPECIAL ATTN. NEEDED

**ANIMAL ALERT CARD**  
CONTACT NAME \_\_\_\_\_  
 ADDRESS \_\_\_\_\_  
 HOME PHONE \_\_\_\_\_ CELL \_\_\_\_\_  
 OWNER NAME \_\_\_\_\_

In case of emergency or if above contact cannot be located, call:  
  
**Hilary P. Simon, D.V.M.**  
 1234 West 4th Street  
 Chicago, IL 5123  
 (217) 555-1234

Patent Pending

Call for pricing on Personalized Cards.  
Imprint area: 1-1/2"W x 1/2"H

## care instruction labels

### UNDER MEDICATION

**V-AN209** Fl-Pink – 560 / Roll  
1-5/8"W x 7/8"H (R)

### WATER ONLY NO FOOD

**V-AN280** Fl-Yellow – 560 / Roll  
1-5/8"W x 7/8"H (R)

### Surgery in A.M. Remove Food 8:00 p.m.

**V-AN604** Fl-Orange – 560 / Roll  
1-5/8"W x 7/8"H (R)

### SEIZURE WATCH

**V-AN443** Fl-Red – 560 / Roll  
1-5/8"W x 7/8"H (R)

### BATH

**V-AN216** Fl-Orange – 560 / Roll  
1-5/8"W x 7/8"H (R)

### GROOM

**V-AN284** Fl-Orange – 560 / Roll  
1-5/8"W x 7/8"H (R)

### NPO

**V-SY229** Fl-Red – 420 / Roll  
2-1/4"W x 7/8"H (R)

*Write your own message*

**MAP500** Fl-Green – 300 / Roll  
2-1/2"W x 3/4"H (P)

care instruction labels

**CAUTION**

V-AN274 Fl-Red – 560 / Roll  
1-5/8"W x 7/8"H (R)

**DO NOT FEED  
OR WATER**

V-AN213 Fl-Green – 560 / Roll  
1-5/8"W x 7/8"H (R)

**PET CARRIER**

PATIENT: \_\_\_\_\_

V-AN642 Fl-Yellow – 560 / Roll  
1-5/8"W x 7/8"H (R)

**WILL  
BITE**

V-AN244 Black/Fl-Red Type – 560 / Roll  
1-5/8"W x 7/8"H (R)

**SURGERY  
DO NOT FEED OR  
WATER TODAY**

V-AN220 Fl-Pink – 560 / Roll  
1-5/8"W x 7/8"H (R)

**SPECIAL DIET**

V-AN254 Fl-Yellow – 560 / Roll  
1-5/8"W x 7/8"H (R)

**ON  
MEDICATION**

V-AN275 Fl-Pink – 560 / Roll  
1-5/8"W x 7/8"H (R)

**OWN FOOD**

V-AN620 Fl-Green – 560 / Roll  
1-5/8"W x 7/8"H (R)

**SAVE  
STOOL**

V-AN210 Fl-Pink – 560 / Roll  
1-5/8"W x 7/8"H (R)

**APPROACH  
SLOWLY**

V-AN278 Fl-Red – 560 / Roll  
1-5/8"W x 7/8"H (R)

**DO NOT  
FEED**

V-AN205 Fl-Pink – 560 / Roll  
1-5/8"W x 7/8"H (R)

**SAVE ALL  
URINE**

V-AN204 Fl-Yellow – 560 / Roll  
1-5/8"W x 7/8"H (R)

**BOARD**

V-AN153 Lt. Blue – 560 / Roll  
1-5/8"W x 7/8"H (R)

**MIGHT  
BITE**

V-AN156 Fl-Pink – 560 / Roll  
1-5/8"W x 7/8"H (R)

**MUZZLE**

V-AN273 Fl-Green – 560 / Roll  
1-5/8"W x 7/8"H (R)

**AGGRESSIVE  
ANIMAL**

V-AN486 Black/Fl-Red Type – 560 / Roll  
1-5/8"W x 7/8"H (R)

**SURGERY  
TODAY**

V-AN217 Fl-Green – 560 / Roll  
1-5/8"W x 7/8"H (R)

**VACCINATE**

V-AN222 Fl-Pink – 560 / Roll  
1-5/8"W x 7/8"H (R)

**URINE  
SPECIMEN**

V-AN261 Fl-Green – 560 / Roll  
1-5/8"W x 7/8"H (R)

**SPECIAL  
DIET**

V-AN223 Fl-Orange – 560 / Roll  
1-5/8"W x 7/8"H (R)

**To Go  
Home**

V-AN286 Fl-Pink – 560 / Roll  
1-5/8"W x 7/8"H (R)

**FOR  
EUTHANASIA**

V-AN125 Fl-Yellow – 560 / Roll  
1-5/8"W x 7/8"H (R)

**BRING  
FRESH  
STOOL  
SAMPLE**

V-AN299 Fl-Orange – 885 / Roll  
1" Dia (R)

## allergy warning labels



**MEDICAL ALERT**

V-MC218 Fl-Red – 560 / Roll  
1-5/8"W x 7/8"H (P)



**ALLERGIC TO:**

MAP3320 Fl-Orange – 250 / Roll  
1-1/2"W x 7/8"H (P)



**ALLERGIC TO:**

UL180 Fl-Red – 500 / Roll  
1-5/8"W x 7/8"H (P)



**NO KNOWN ALLERGIES**

MAP1510 Lt-Blue – 250 / Roll  
1-1/2"W x 7/8"H (P)



**ALLERGIC TO:**

MAP3350 Fl-Pink – 250 / Roll  
1-1/2"W x 7/8"H (P)



## medical record sheets

Printed 2-sided on heavy-duty 100 lb. stock.

FRONT

BACK

V-CF100 Blue – 250 / Pack  
8-1/2"W x 11"H (\*)

FRONT

BACK

V-CF101 Green – 250 / Pack  
8-1/2"W x 11"H (\*)

## authorization and consent labels

### AUTHORIZATION TO PERFORM EUTHANASIA

Date \_\_\_\_\_

As owner, or duly authorized agent of the owner, of the animal described hereon, I hereby consent to and order, euthanasia to be performed on same for humane reasons. I further authorize the attending veterinarian to dispose of the remains in accordance with hospital policy. YES  NO

To the best of my knowledge and belief this animal has not bitten any person during the fifteen days preceding this date.

Signature \_\_\_\_\_

V-AN424 White - 240 / Roll 4"W x 2-5/8"H (P) (\*)

### AUTHORIZATION TO PERFORM EUTHANASIA

I am the owner, or authorized agent of the owner, of the animal described hereon and I hereby consent to, and order euthanasia to be performed on the same for humane reasons, and in a humane manner.

I further authorize the attending veterinarian to dispose of the remains in accordance with hospital policy, unless otherwise instructed.

To my best knowledge and belief this animal has not bitten any person during the fifteen (15) days preceding this date.

grant/  refuse permission for a postmortem study.

Date \_\_\_\_\_

Signature \_\_\_\_\_

Name \_\_\_\_\_

Species \_\_\_\_\_

Breed \_\_\_\_\_

Sex \_\_\_\_\_

Age \_\_\_\_\_

Color \_\_\_\_\_

V-AN408 White - 240 / Roll 4"W x 2-5/8"H (P) (\*)

### SURGICAL AND HOSPITALIZATION AUTHORIZATION

I hereby consent and authorize \_\_\_\_\_ to receive, prescribe for, treat, or operate upon my animal(s).

You are to use all reasonable precautions against injury, escape, or destruction of the animal(s), but you will not be held liable or responsible in any manner whatever, or any circumstances, on account of the care, treatment or safekeeping of the animal(s) named below, or otherwise in connection therewith, as it is thoroughly understood that I assume all risks. Financial responsibility for services rendered is due at time of discharge.

I also understand that \_\_\_\_\_ is not staffed twenty-four (24) hours a day and afterhour treatment of patients is at the discretion of the veterinarian.

Signature \_\_\_\_\_ Date \_\_\_\_\_

Phone # \_\_\_\_\_ Name(s) \_\_\_\_\_

V-AN435 White - 240 / Roll 4"W x 2-5/8"H (P) (\*)

## vaccination record labels

### SITE OF VACCINATION

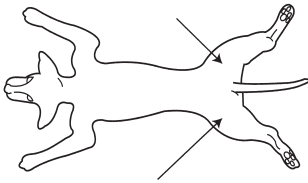

Given By: \_\_\_\_\_ DVM/CVT

V-AN451 White - 320 / Roll  
2-1/2"W x 2-1/2"H (P) (\*)

### SITE OF VACCINATION

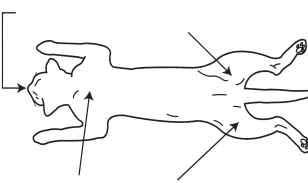

Given By: \_\_\_\_\_ DVM/CVT

V-AN452 White - 320 / Roll  
2-1/2"W x 2-1/2"H (P) (\*)

### RABIES

MFG \_\_\_\_\_

SERIAL # \_\_\_\_\_

TAG # \_\_\_\_\_

V-AN601 Fl-Green - 560 / Roll  
1-5/8"W x 7/8"H (P) (\*)

## x-ray labels

### X-RAY

Name: \_\_\_\_\_ No. \_\_\_\_\_

Date: \_\_\_\_\_ DV  LAT

Taken by: \_\_\_\_\_ AP

KV: \_\_\_\_\_ Exp.: \_\_\_\_\_ VD

Comments: \_\_\_\_\_

\_\_\_\_\_

\_\_\_\_\_

\_\_\_\_\_

V-AN417 White - 240 / Roll 4"W x 2-5/8"H (P) (\*)

## inventory control & sterilization labels

Date Rec d \_\_\_\_\_

Date Opened \_\_\_\_\_

Exp. Date \_\_\_\_\_

V-LR138 Yellow - 560 / Roll  
1-5/8"W x 7/8"H (R) (\*)

DATE

OPENED

V-FP703 Fl.-Yellow - 570 / Roll  
3/4" Dia. (R) (\*)

## examination record labels

### Dental Examination Records

**DENTAL** Name \_\_\_\_\_ Date \_\_\_\_\_

**KEY:** O = Displaced Tooth  
X = Missing Tooth  
↙ = Caries, Injury, FX

a \_\_\_\_\_  
b \_\_\_\_\_  
c \_\_\_\_\_  
d \_\_\_\_\_  
Gingiva: \_\_\_\_\_  
Occlusion: \_\_\_\_\_  
Salivation: \_\_\_\_\_  
Halitosis: Y N  
Periodontal Disease: \_\_\_\_\_  
Other: \_\_\_\_\_

V-AN650 White - 240 / Roll  
4"W x 2-5/8"H (P) (\*)

**CANINE DENTAL RECORD**  
FOR \_\_\_\_\_

R UPPER L L LOWER R

V-AN432 White - 390 / Roll  
2-1/2"W x 2-1/2"H (P) (\*)

**DENTAL** Name \_\_\_\_\_ Date \_\_\_\_\_

**KEY:** O = Displaced Tooth  
X = Missing Tooth  
↙ = Caries, Injury, FX

a \_\_\_\_\_  
b \_\_\_\_\_  
c \_\_\_\_\_  
d \_\_\_\_\_  
Gingiva: \_\_\_\_\_  
Occlusion: \_\_\_\_\_  
Salivation: \_\_\_\_\_  
Halitosis: Y N  
Periodontal Disease: \_\_\_\_\_  
Other: \_\_\_\_\_

V-AN412 White - 240 / Roll  
4"W x 2-5/8"H (P) (\*)

**FELINE DENTAL RECORD**  
FOR \_\_\_\_\_

R UPPER L L LOWER R  
FELINE

V-AN411 White - 390 / Roll  
2-1/2"W x 2-1/2"H (P) (\*)

### Annual Visit

**ANNUAL VISIT** Name \_\_\_\_\_ Date \_\_\_\_\_

DA<sub>2</sub>PL  PARVO  CORONA  RAB  FVRCP  FeLV

**HEARTWORM:**  Neg.  Pos. **FECAL:** Round  Hook   
On Medication  Yes  No Whip  Tape   
Type \_\_\_\_\_  All Year  Neg.

N A	N A	Rx
ENT <input type="checkbox"/>	TEETH <input type="checkbox"/>	_____
UG <input type="checkbox"/>	EYES <input type="checkbox"/>	_____
HL <input type="checkbox"/>	SKIN <input type="checkbox"/>	Comments: _____
GI <input type="checkbox"/>	LN <input type="checkbox"/>	_____
		_____

Age \_\_\_\_\_ Wt. \_\_\_\_\_ Temp. \_\_\_\_\_ Food Type \_\_\_\_\_

V-AN450 White - 240 / Roll  
4"W x 2-5/8"H (P) (\*)

**ANNUAL VISIT** Name \_\_\_\_\_ Date \_\_\_\_\_

DHLPP  PARVO  CORONA  RAB  FVRCP  FeLV

**HEARTWORM:**  Neg.  Pos. **FECAL:** Round  Hook   
On Medication  Yes  No Whip  Tape   
Type \_\_\_\_\_  All Year  Neg.

N A	N A	Rx
ENT <input type="checkbox"/>	TEETH <input type="checkbox"/>	_____
UG <input type="checkbox"/>	EYES <input type="checkbox"/>	_____
HL <input type="checkbox"/>	SKIN <input type="checkbox"/>	Comments: _____
GI <input type="checkbox"/>	LN <input type="checkbox"/>	_____
		_____

Age \_\_\_\_\_ Wt. \_\_\_\_\_ Temp. \_\_\_\_\_ Food Type \_\_\_\_\_

V-AN413 White - 240 / Roll  
4"W x 2-5/8"H (P) (\*)

# examination record labels

## Physical Examination



### PHYSICAL EXAM CHECKLIST

NAME: \_\_\_\_\_ OWNER: \_\_\_\_\_  
 DIET: \_\_\_\_\_ VACCINATIONS: \_\_\_\_\_  
 FECAL: \_\_\_\_\_ HEARTWORM CHECK: \_\_\_\_\_

GENERAL APPEARANCE ( ) NORM ( ) ABNORM	INTEGUMENTARY ( ) NORM ( ) ABNORM	MUSCULO-SKELETAL ( ) NORM ( ) ABNORM	CIRCULATORY ( ) NORM ( ) ABNORM
RESPIRATORY ( ) NORM ( ) ABNORM	DIGESTIVE ( ) NORM ( ) ABNORM	GENITO URINARY ( ) NORM ( ) ABNORM	EYES ( ) NORM ( ) ABNORM
EARS ( ) NORM ( ) ABNORM	NEURAL SYSTEM ( ) NORM ( ) ABNORM	LYMPH NODES ( ) NORM ( ) ABNORM	MUCOUS MEMBRANES ( ) NORM ( ) ABNORM
BT _____ HR _____ RR _____ Wt. _____			DENTAL ( ) NORM ( ) ABNORM

V-AN407 White - 240 / Roll  
4"W x 2-5/8"H (\*) (R)

### PHYSICAL EXAMINATION

(1) GENERAL APPEARANCE <input type="checkbox"/> Normal <input type="checkbox"/> Abnormal <input type="checkbox"/> Not examined	(2) INTEGUMENTARY <input type="checkbox"/> Normal <input type="checkbox"/> Abnormal <input type="checkbox"/> Not examined	(3) MUSCULO-SKELETAL <input type="checkbox"/> Normal <input type="checkbox"/> Abnormal <input type="checkbox"/> Not examined	(4) CIRCULATORY <input type="checkbox"/> Normal <input type="checkbox"/> Abnormal <input type="checkbox"/> Not examined
(5) RESPIRATORY <input type="checkbox"/> Normal <input type="checkbox"/> Abnormal <input type="checkbox"/> Not examined	(6) DIGESTIVE <input type="checkbox"/> Normal <input type="checkbox"/> Abnormal <input type="checkbox"/> Not examined	(7) GENITO-URINARY <input type="checkbox"/> Normal <input type="checkbox"/> Abnormal <input type="checkbox"/> Not examined	(8) EYES <input type="checkbox"/> Normal <input type="checkbox"/> Abnormal <input type="checkbox"/> Not examined
(9) EARS <input type="checkbox"/> Normal <input type="checkbox"/> Abnormal <input type="checkbox"/> Not examined	(10) NEURAL SYSTEMS <input type="checkbox"/> Normal <input type="checkbox"/> Abnormal <input type="checkbox"/> Not examined	(11) LYMPH NODES <input type="checkbox"/> Normal <input type="checkbox"/> Abnormal <input type="checkbox"/> Not examined	(12) MUCOUS MEMBRANES <input type="checkbox"/> Normal <input type="checkbox"/> Abnormal <input type="checkbox"/> Not examined

DESCRIBE ABNORMAL (Use numbers above) T \_\_\_\_\_ P \_\_\_\_\_ R \_\_\_\_\_ Wt. \_\_\_\_\_  
 SCALE  EST

V-AN494 White - 240 / Roll  
4-3/4"W x 1-7/8"H (\*) (P)

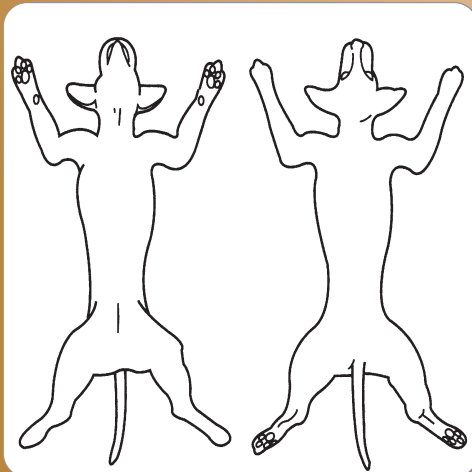

V-AN315 White - 320 / Roll  
2-1/2"W x 2-1/2"H (\*) (P)

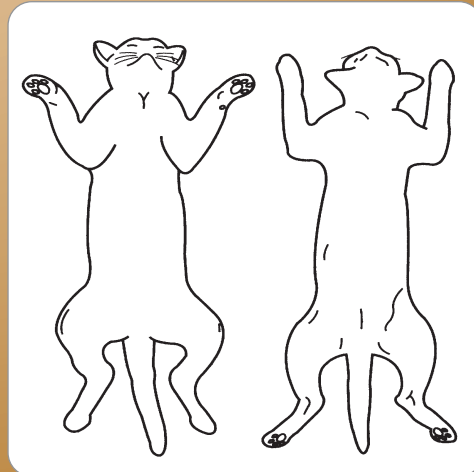

V-AN316 White - 320 / Roll  
2-1/2"W x 2-1/2"H (\*) (P)

## laboratory labels

### Urinalysis

**URINALYSIS**

Breed \_\_\_\_\_ Age \_\_\_\_\_ Sex \_\_\_\_\_  
 Method of collection \_\_\_\_\_  
 Transparency \_\_\_\_\_ Sediment \_\_\_\_\_  
 Sp. Gr. \_\_\_\_\_ RBC \_\_\_\_\_ I/HPF  
 Color \_\_\_\_\_ WBC \_\_\_\_\_ I/HPF  
 PH. \_\_\_\_\_ Cells \_\_\_\_\_ I/HPF  
 Protein \_\_\_\_\_ Casts \_\_\_\_\_ I/HPF  
 Glucose \_\_\_\_\_ Crystals \_\_\_\_\_ I/HPF  
 Ketones \_\_\_\_\_ Bacteria \_\_\_\_\_ I/HPF  
 Bili. \_\_\_\_\_ Sperm \_\_\_\_\_ I/HPF  
 Bid. \_\_\_\_\_  
 Urobil \_\_\_\_\_ Pet \_\_\_\_\_  
 Nitrites \_\_\_\_\_ Dr. \_\_\_\_\_

V-AN300 Fl-Yellow – 320 / Roll 3"W x 2"H (P) (\*)

**URINALYSIS**

Name: \_\_\_\_\_ Date: \_\_\_\_\_  
 Appearance: \_\_\_\_\_ Blood: \_\_\_\_\_  
 Color: \_\_\_\_\_ Bilirubin: \_\_\_\_\_  
 Protein: \_\_\_\_\_ Ketones: \_\_\_\_\_  
 Spec Grav: \_\_\_\_\_ Glucose: \_\_\_\_\_  
 Sediment: \_\_\_\_\_ Urobilinogen: \_\_\_\_\_  
 Bacteria: \_\_\_\_\_ RBC: \_\_\_\_\_  
 WBC: \_\_\_\_\_ Crystals: \_\_\_\_\_  
 Casts: \_\_\_\_\_ Epithelium: \_\_\_\_\_  
 pH: \_\_\_\_\_ Notes: \_\_\_\_\_

V-AN415 White – 240 / Roll 4"W x 2-5/8"H (P) (\*)

**URINALYSIS** Name \_\_\_\_\_ Date \_\_\_\_\_

Method of Collection \_\_\_\_\_ Midstream Catch \_\_\_\_\_  
 Color: \_\_\_\_\_ Glucose \_\_\_\_\_ Ketones \_\_\_\_\_ pH \_\_\_\_\_  
 Appearance: \_\_\_\_\_ Spec. Grav.: \_\_\_\_\_ Protein: \_\_\_\_\_  
 Bile \_\_\_\_\_ Urobilinogen \_\_\_\_\_ Blood: \_\_\_\_\_  
 Other: \_\_\_\_\_  
 SEDIMENT: Casts: \_\_\_\_\_ WBC: \_\_\_\_\_  
 Epithelia: \_\_\_\_\_ RBC: \_\_\_\_\_ Bacteria: \_\_\_\_\_  
 Crystals: Type & # \_\_\_\_\_  
 Other \_\_\_\_\_  
 Interpretation: \_\_\_\_\_

V-AN436 White – 240 / Roll 4"W x 2-5/8"H (P) (\*)

**FECAL**

Result: \_\_\_\_\_  
 Date: \_\_\_\_\_

V-AN607 Fl-Yellow – 560 / Roll  
1-5/8"W x 7/8"H (P) (\*)

**Heartworm**

+      -

Date \_\_\_\_\_

V-AN295 Fl-Orange – 560 / Roll  
1-5/8"W x 7/8"H (P) (\*)

**FECAL**

+      -

V-AN617 Fl-Green – 560 / Roll  
1-5/8"W x 7/8"H (P) (\*)

**BLOOD**

WBC _____	RBC _____
SEG _____	HGB _____
Band _____	HCT _____
Lymph _____	Plat _____
MONO _____	TP _____
EOSIN _____	
BASO _____	

V-AN270 Fl-Pink – 420 / Roll  
2-1/4"W x 7/8"H (P) (\*)

NAME: \_\_\_\_\_ DATE: \_\_\_\_\_

Urine \_\_\_\_\_  
 S.G. \_\_\_\_\_ pH \_\_\_\_\_ BL \_\_\_\_\_ Bil \_\_\_\_\_  
 KET \_\_\_\_\_ GLU \_\_\_\_\_ PR \_\_\_\_\_ UROB \_\_\_\_\_  
 SED \_\_\_\_\_

V-AN627 White/Blue Type – 420 / Roll  
2-1/4"W x 7/8"H (P) (\*)



## iv/medication added labels

Our detail-oriented **iv therapy labels** are essential to patient safety. Use them whenever IV medications are being administered to clearly communicate critical information. Intended for use on base labels only.

### IV Therapy

**MEDICATION  
ADDED TO I.V.**

---

Time	Date	By
Drug	Quantity	

Expires: Date \_\_\_\_\_ Time \_\_\_\_\_

V-HH207 Fl.-Red – 390 / Roll  
2-1/2"W x 2-1/2"H (P)

**MEDICATION  
ADDED TO I.V.**

---

PTS. NAME \_\_\_\_\_

ADDED BY \_\_\_\_\_

RETURN TO PHARMACY ON OR  
BEFORE \_\_\_\_\_

V-HH502 Fl.-Red – 320 / Roll  
2"W x 3"H (P)

**CHEMOTHERAPY**

V-HN119 Fl.-Pink – 760 / Roll  
1-1/4"W x 5/16"H (R)

**HEPARIN FLUSH**

\_\_\_\_\_ UNITS

V-IV111 Fl.-Red – 760 / Roll  
1-1/4"W x 5/16"H (P)

**HEPARIN  
FLUSH**

V-IV213 Fl.-Red – 420 / Roll  
2-1/4"W x 7/8"H (P)

## drug syringe labels

**HEPARINIZED  
SALINE**

V-AM723 White – 760 / Roll  
1-1/4"W x 5/16"H (P)

**ANTIBIOTIC**  
\_\_\_\_\_ mg

V-AN468 White – 760 / Roll  
1-1/4"W x 5/16"H (P)

**KETAMINE** \_\_\_\_\_ mg  
**VALIUM** \_\_\_\_\_ mg

V-AN455 Fl.-Red – 760 / Roll  
1-1/4"W x 5/16"H (P)

**BUTORPHANOL**  
\_\_\_\_\_ mg

V-AN467 Fl.-Yellow – 760 / Roll  
1-1/4"W x 5/16"H (P)

**DIAZEPAM**  
\_\_\_\_\_ mg/ml

V-AM794 Fl.-Orange – 760 / Roll  
1-1/4"W x 5/16"H (P)

**PROPOFOL**  
\_\_\_\_\_ mg/ml

V-AM006 Fl.-Yellow – 760 / Roll  
1-1/4"W x 5/16"H (P)

\_\_\_\_\_ CC

V-AN140 Fl.-Yellow – 760 / Roll  
1-1/4"W x 5/16"H (P)

**NORMAL  
SALINE**

V-AM141 Fl.-Orange – 760 / Roll  
1-1/4"W x 5/16"H (P)

**MORPHINE**  
\_\_\_\_\_ mg/ml

V-AM762 Lt. Blue – 760 / Roll  
1-1/4"W x 5/16"H (P)

## medication instruction labels

**KEEP IN REFRIGERATOR**

V-FP109 Blue – 500 / Roll  
1-5/8"W x 3/8"H (P) (\*)

**SHAKE WELL BEFORE USING**

V-FP110 Blue – 500 / Roll  
1-5/8"W x 3/8"H (P) (\*)

**CAUTION:** Dogs **MUST** be blood tested **EVERY YEAR** before using this medicine. Severe reaction can occur if dog has heartworm infection.

V-AN236 Fl.-Red – 560 / Roll  
1-5/8"W x 7/8"H (P) (\*)

**FOR VETERINARY USE ONLY  
KEEP OUT OF CHILDREN'S REACH**

V-AN104 White/Red Type – 500 / Roll  
1-5/8"W x 3/8"H (P) (\*)

**FOR REFILLS  
PLEASE PHONE AHEAD**

V-FP700 White/Blue Type – 500 / Roll  
1-5/8"W x 3/8"H (P) (\*)

**CAUTION:** Failure to use and refill this medication may lead to fatal heartworm disease.

V-AN252 Fl.-Red – 560 / Roll  
1-5/8"W x 7/8"H (P) (\*)

**GIVE UNTIL GONE**

V-AN111 Red – 500 / Roll  
1-5/8"W x 3/8"H (P) (\*)

**FOR THE EAR**

V-AN656 Blue – 500 / Roll  
1-5/8"W x 3/8"H (P) (\*)

**This prescription cannot be refilled without bloodwork.**

V-AN150 White/Blue Type – 500 / Roll  
1-5/8"W x 3/8"H (P) (\*)

**REFILL WHEN EMPTY**

V-AN103 White/Red Type – 500 / Roll  
1-5/8"W x 3/8"H (P) (\*)

**WARNING:** BEFORE HEARTWORM PREVENTION CAN BE STARTED YOUR PET MUST HAVE A CURRENT HEARTWORM TEST WITH NEGATIVE RESULTS

V-AN229 Fl.-Orange – 420 / Roll  
2-1/4"W x 7/8"H (P) (\*)

**FOR THE EYE**

V-AN657 Red – 500 / Roll  
1-5/8"W x 3/8"H (P) (\*)

**This prescription cannot be refilled without an exam.**

V-AN124 White/Blue Type – 500 / Roll  
1-5/8"W x 3/8"H (P) (\*)

**GIVE WITH FOOD**

V-AN119 White/Red Type – 500 / Roll  
1-5/8"W x 3/8"H (P) (\*)

**CAUTION: May Cause Drowsiness**

V-AN123 Fl.-Pink – 500 / Roll  
1-5/8"W x 3/8"H (P) (\*)

Continue this medication YEAR ROUND and REFILL as necessary. ANNUAL heartworm testing is recommended.

V-AN636 Fl.-Green – 420 / Roll  
2-1/4"W x 7/8"H (P) (\*)

**Keep in Refrigerator  
DO NOT FREEZE**

V-FP105 Blue – 500 / Roll  
1-5/8"W x 3/8"H (P) (\*)

**EXTERNAL USE ONLY**

V-AN121 Fl.-Yellow – 500 / Roll  
1-5/8"W x 3/8"H (P) (\*)

We recommend year-round treatment for effective flea control in this climate.

V-AN659 Fl.-Yellow – 420 / Roll  
2-1/4"W x 7/8"H (P) (\*)

 **Refrigerate and Shake Well Before Using**

V-FP704 White/Blue Type – 500 / Roll  
1-5/8"W x 3/8"H (P) (\*)

## billing & collection labels

*Just a friendly reminder*  
that your account is overdue. Won't you please mail your remittance?

MAP4220 Fl.-Green – 250 / Roll  
1-1/2"W x 7/8"H (P)



**WE HATE TO KEEP HOUNDING YOU, BUT YOUR BILL IS PAST DUE.**

UL520 Fl.-Pink – 420 / Roll  
2-1/4"W x 7/8"H (P)

**WE ACCEPT MAJOR CREDIT CARDS**

To pay with your credit card please complete:

Acct. No. \_\_\_\_\_  
VISA \_\_\_\_\_ MasterCard \_\_\_\_\_ American Ex \_\_\_\_\_ Discover \_\_\_\_\_  
Exp. Date \_\_\_\_\_ Signature \_\_\_\_\_

MAP5790 Fl.-Chartreuse – 250 / Roll  
3"W x 1"H (P)

## made-to-order dividers

### CUSTOM INDEX:

#### Easy Ordering Instructions:

- Specify paper weight and divider color:
  - 90 lb. or 110 lb.
  - White or Ivory (Manila) Stock
- Choose tab print style and punch hole positions:
  - Side or Bottom Tabs
  - 5, 3, or 2 hole punch
- Specify tab cut size (see charts) and tab extension
- List tab titles, positions, and colors
- Choose packaging options:
  - Collated / titles boxed together in sets
  - Non-Collated / each title boxed individually



- ◆ 90 lb. or 110 lb. White or Ivory Stock
- ◆ Side or Bottom indexing
- ◆ Reinforced 5, 3 or 2 hole punch
- ◆ Mylar® reinforced tabs printed on one or two sides
- ◆ Available tab extensions: 1/4", 3/8" or 1/2"
- ◆ Available in pre-collated sets or individual tab sheets
- ◆ Black printing on body copy available

### CUSTOM FILEBACK:

#### Easy Ordering Instructions:

- Specify Side or Bottom tabs
- Choose Fastener: Top or Side
- Specify Style: Hinge or Self-Adhesive
- List tab titles, positions, and colors
- Choose packaging options:
  - Collated / titles boxed together in sets
  - Non-Collated / each title boxed individually



- ◆ 110 lb. Ivory Stock
- ◆ Side or Bottom indexing
- ◆ 2" Heat Bonded Fastener
- ◆ Scored hinge with Mylar® reinforced slots or self-adhesive transfer tape
- ◆ Mylar® reinforced tabs printed on one or two sides
- ◆ Available tab extensions: 1/2" or 3/8"
- ◆ Available in pre-collated sets or individual tab sheets
- ◆ Black printing on body copy available

## file folders

Manila **file folders** with or without fasteners. 12-1/4"W x 9-1/2"H overall size

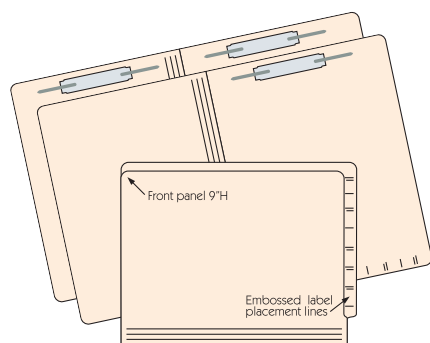

### 11 PT. 2-Ply Letter

stock no.	fastener position(s)	folders/case
56012	–	500
560121	1	250
5601213	1 & 3	250

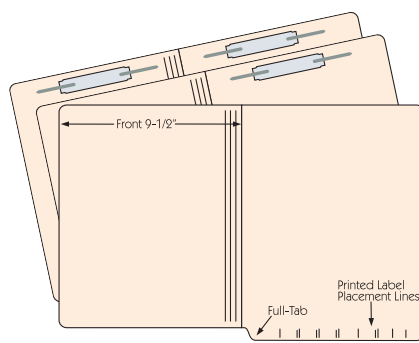

### 11 PT. 2-Ply Letter

stock no.	fastener position(s)	folders/case
56018	–	500
560181	1	250
5601813	1 & 3	250

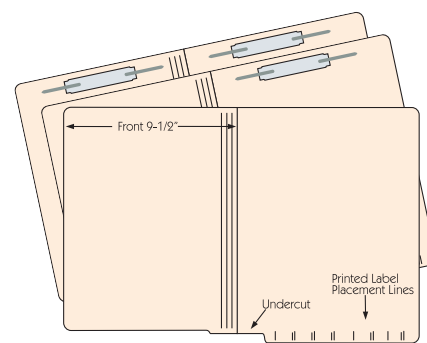

### 11 PT. 2-Ply Letter

stock no.	fastener position(s)	folders/case
56022	–	500
56023	1	250
56024	1 & 3	250

### 14 PT. 1-Ply Letter

56015	–	500
560151	1	250
5601513	1 & 3	250

### 14 PT. 1-Ply Letter

56019	–	500
560191	1	250
5601913	1 & 3	250

### 14 PT. 1-Ply Letter

56025	–	500
560251	1	250
5602513	1 & 3	250

## combination drawer/shelf file folders

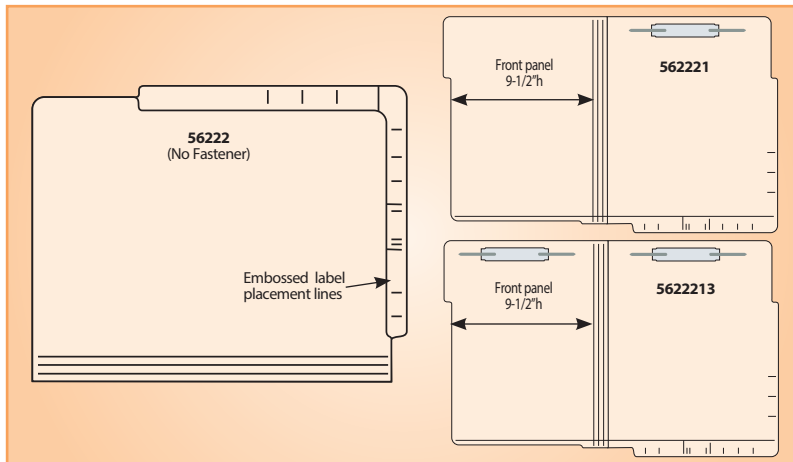

### 11 pt. 2-Ply (Reinforced) Letter

Manila **combination drawer / shelf file folder** design can be used as top tab in a drawer or as an end tab in an open shelf. Large tab area on top and side allows plenty of room for all your labeling needs. Available with or without fasteners. 12"W x 9-1/2"H overall size.

stock no.	fastener position(s)	folders/case
56222	-	500
562221	1	250
5622213	1 & 3	250

## self-adhesive divider sheets

8-1/2"W x 11"H (not including flap)

Quickly divide the contents of your folders with our easy to install **self-adhesive divider sheets**.

Dividers are 11 pt. manila stock. Die-cuts on flap allow for easy positioning around fasteners.

100 dividers per package.

stock no.	fastener position(s)
26330	None
263301	1-Fastener Front Top - Pos. #1
263305	1-Fastener Front Top - Pos. #5
2633013	2-Fasteners Top two sides - Pos. #1 & #3



## file folder fasteners



Self-adhesive **foamclip® fasteners** are a perfect choice for organizing any 2-hole punched papers. These fasteners bond permanently to file folders, pressboard, plastic, wood, glass, even metal. With their superior strength, **foamclip® fasteners** can't be pulled off like other brands! The 2-3/4" center-to-center, 1-1/2" capacity fastener is easy to use; just peel off backing paper and press fastener into place.

stock no.	description	fasteners/box
56807	foamclip fasteners	100



**duo-prong fasteners** are used when fasteners are required on both the front and back of a divider sheet for 2-hole punched documents. Fastener capacity is 1" on one side and 5/8" on the other. Simply insert 1" prongs thru slits in divider sheet, and bend prongs back. No adhesive required.

stock no.	description	fasteners/box
26808	duo-prong fasteners	100



Self-adhesive **sup'r'grip fasteners** are an ideal space-saving solution for large files. Long 2" prongs accommodate 2-hole punched material, while the ultra-thin design saves valuable filing space. Fasteners are heat bonded onto pressure-sensitive, 60 lb. manila-colored paper to hold even the bulkiest files without tearing. Printed aligning guides on each strip ensure accurate placement. 4 fasteners per sheet; 25 sheets per box.

stock no.	description	fasteners/box
56805	sup'r'grip fasteners	100

## lock-it pockets



Peel off self-adhesive 5 mil **lock-it pocket**. Permanently apply to your folders or wherever it is most convenient. Durable, clear polyethylene ziplock style secures small documents, including photos, diskettes, CD's, x-rays and much more. Clear front keeps important information at full view without opening the pocket.

stock no.	inside	outside	pockets/box
54470	5" w x 5-1/4" h	5-1/2" w x 6-1/4" h	100
54471	6" w x 9" h	6-1/2" w x 10" h	100

First dimension is the pocket opening

## poly & vinyl pockets

Clear see-thru pockets are available in several sizes to fit all your needs. It's easy to add a pocket to your file or binder; simply peel off the protective backing and apply the self-adhesive side to your folder. Pockets are sealed on three sides. Store x-rays, forms, immunization records, computer diskettes, CD's and more.

**POLY POCKETS** provide easy access to information.

stock no.	inside	outside	pockets/box
54495	2-1/2" w x 3-1/4" h	3" w x 3-3/4" h	100
54496	10-1/2" w x 8-1/2" h	11" w x 9" h	100
54497	5" w x 3" h	5-3/4" w x 3-3/4" h	100
54498	6-1/2" w x 4-1/4" h	7" w x 4-3/4" h	100
54499	8-3/4" w x 5-1/2" h	9-1/4" w x 6" h	100

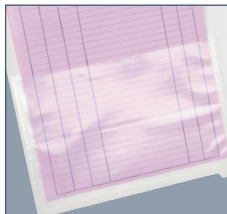

**VINYL POCKETS** are textured and heavy-duty.

stock no.	inside	outside	pockets/box
54492	8-3/4" w x 11-1/4" h	9" w x 11-1/2" h	100
54493	5-1/4" w x 3-1/4" h	5-1/2" w x 3-1/2" h	100
54494	8-3/4" w x 5-1/2" h	9" w x 5-3/4" h	100

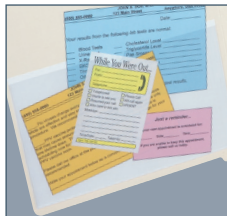

First dimension is the pocket opening

## cov'r'tabs

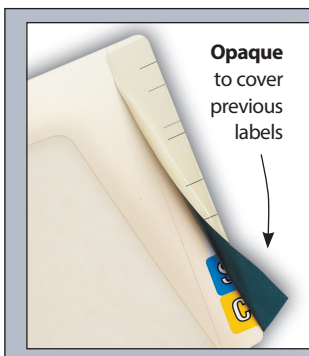

**Opaque** to cover previous labels

- ◆ Easy way to re-use old folders.
- ◆ Self-adhesive and wrap-around design adds reinforcement to tab.
- ◆ Printed score marks for even positioning of new labels.
- ◆ 60 lb. in manila color finish.
- ◆ Strip must be applied to folder "before" application of new labels.

stock no.	size	cov'r'tabs/pkg.
55990	2-1/2" w x 8" h	50

## file folder label protectors



End Tab

**file folder label protectors** eliminate dirty, worn, dog-eared file folders and file folder labels. Clear, wrap-around, self-adhesive protectors keep file folders and labels clean and prevent them from falling off, extending the life of the folder. Name label protectors can also be used "flat" to attach miscellaneous materials to any surface.

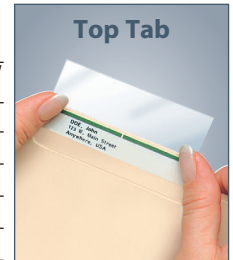

Top Tab

stock no.	size	protectors/pkg.	pkgs./box	protectors/roll
58385	3-1/2" w x 2" h	100	5	-
58485	4" w x 2" h	100	5	-
58385B	3-1/2" w x 1-3/4" h	-	500*	-
88385	3-1/2" w x 2" h	-	-	500
88485	4" w x 2" h	-	-	500

\*500 single protectors per box

## full end tab protectors



**end tab protectors** are an ideal solution for extending the life of shelf file folders. Clear protectors wrap around folder end tabs, preventing labels from cracking or popping off, and protect against wear and tear. Self-adhesive, 8" x 2" protectors can be easily applied to all types of end tab file folders to keep them looking neat and clean longer.

stock no.	size	protectors/pkg.
68386	8" h x 2" w	100

## spine edge protectors



**spine edge protectors** keep heavily used file folders looking good longer by protecting edges from cracking or splitting.

The 11" x 2" clear, wrap-around protector is easily applied to the bottom edge of a file folder, where the most wear and tear occurs as the folder is moved in and out of shelf file cabinets.

stock no.	size	protectors/pkg.
68387	11" w x 2" h	100

## color code labels



**Original Col'R'Tab® series**  
 1"H x 1-1/2"W (P) (L)  
**Roll Unit** - 42000 (28 rolls)  
**Desktop Kit** -  
 32000 (3,200 labels)

500/Roll 100/Pkg.

12001 - Roll 82001 - Pkg.	12002 - Roll 82002 - Pkg.	12003 - Roll 82003 - Pkg.	12004 - Roll 82004 - Pkg.	12005 - Roll 82005 - Pkg.	12006 - Roll 82006 - Pkg.	12007 - Roll 82007 - Pkg.
12008 - Roll 82008 - Pkg.	12009 - Roll 82009 - Pkg.	12010 - Roll 82010 - Pkg.	12011 - Roll 82011 - Pkg.	12012 - Roll 82012 - Pkg.	12013 - Roll 82013 - Pkg.	12014 - Roll 82014 - Pkg.
12015 - Roll 82015 - Pkg.	12016 - Roll 82016 - Pkg.	12017 - Roll 82017 - Pkg.	12018 - Roll 82018 - Pkg.	12019 - Roll 82019 - Pkg.	12020 - Roll 82020 - Pkg.	12021 - Roll 82021 - Pkg.
12022 - Roll 82022 - Pkg.	12023 - Roll 82023 - Pkg.	12024 - Roll 82024 - Pkg.	12025 - Roll 82025 - Pkg.	12026 - Roll 82026 - Pkg.	12027 - Roll 82027 - Pkg.	



**Colwell® Jewel-Tone compatible series**  
 1"H x 1-1/2"W (P) (L)  
**Roll Unit** -  
 91420 (28 rolls)

500/Roll 240/Ringbook Pkg.

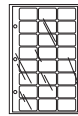

**DON'T FORGET ABOUT AGING LABELS!**

91421 - Roll 61421 - Ring	91422 - Roll 61422 - Ring	91423 - Roll 61423 - Ring	91424 - Roll 61424 - Ring	91425 - Roll 61425 - Ring	91426 - Roll 61426 - Ring	91427 - Roll 61427 - Ring
91428 - Roll 61428 - Ring	91429 - Roll 61429 - Ring	91430 - Roll 61430 - Ring	91431 - Roll 61431 - Ring	91432 - Roll 61432 - Ring	91433 - Roll 61433 - Ring	91434 - Roll 61434 - Ring
91435 - Roll 61435 - Ring	91436 - Roll 61436 - Ring	91437 - Roll 61437 - Ring	91438 - Roll 61438 - Ring	91439 - Roll 61439 - Ring	91440 - Roll 61440 - Ring	91441 - Roll 61441 - Ring
91442 - Roll 61442 - Ring	91443 - Roll 61443 - Ring	91444 - Roll 61444 - Ring	91445 - Roll 61445 - Ring	91446 - Roll 61446 - Ring	91447 - Roll 61447 - Ring	

## color code labels

<b>A A</b> 91521 — Roll 71521 — Pkg. 61521 — Ring	<b>B B</b> 91522 — Roll 71522 — Pkg. 61522 — Ring	<b>C C</b> 91523 — Roll 71523 — Pkg. 61523 — Ring	<b>D D</b> 91524 — Roll 71524 — Pkg. 61524 — Ring	<b>E E</b> 91525 — Roll 71525 — Pkg. 61525 — Ring	<b>F F</b> 91526 — Roll 71526 — Pkg. 61526 — Ring	<b>G G</b> 91527 — Roll 71527 — Pkg. 61527 — Ring
<b>H H</b> 91528 — Roll 71528 — Pkg. 61528 — Ring	<b>I I</b> 91529 — Roll 71529 — Pkg. 61529 — Ring	<b>J J</b> 91530 — Roll 71530 — Pkg. 61530 — Ring	<b>K K</b> 91531 — Roll 71531 — Pkg. 61531 — Ring	<b>L L</b> 91532 — Roll 71532 — Pkg. 61532 — Ring	<b>M M</b> 91533 — Roll 71533 — Pkg. 61533 — Ring	<b>N N</b> 91534 — Roll 71534 — Pkg. 61534 — Ring
<b>O O</b> 91535 — Roll 71535 — Pkg. 61535 — Ring	<b>P P</b> 91536 — Roll 71536 — Pkg. 61536 — Ring	<b>Q Q</b> 91537 — Roll 71537 — Pkg. 61537 — Ring	<b>R R</b> 91538 — Roll 71538 — Pkg. 61538 — Ring	<b>S S</b> 91539 — Roll 71539 — Pkg. 61539 — Ring	<b>T T</b> 91540 — Roll 71540 — Pkg. 61540 — Ring	<b>U U</b> 91541 — Roll 71541 — Pkg. 61541 — Ring
<b>V V</b> 91542 — Roll 71542 — Pkg. 61542 — Ring	<b>W W</b> 91543 — Roll 71543 — Pkg. 61543 — Ring	<b>X X</b> 91544 — Roll 71544 — Pkg. 61544 — Ring	<b>Y Y</b> 91545 — Roll 71545 — Pkg. 61545 — Ring	<b>Z Z</b> 91546 — Roll 71546 — Pkg. 61546 — Ring	<b>MC MC</b> 91547 — Roll 71547 — Pkg. 61547 — Ring	



**Jeter® 5800, 7100, 7200 compatible series**  
15/16"H x 1-5/8"W (P)  
Roll Unit - 91520 (28 rolls)



**Jeter® 0200 compatible series**  
15/16"H x 1-5/8"W (P) (L)

240/Ringbook Pkg.



<b>A A</b> 91721 — Roll 61721 — Ring	<b>B B</b> 91722 — Roll 61722 — Ring	<b>C C</b> 91723 — Roll 61723 — Ring
<b>D D</b> 91724 — Roll 61724 — Ring	<b>E E</b> 91725 — Roll 61725 — Ring	<b>F F</b> 91726 — Roll 61726 — Ring
<b>G G</b> 91727 — Roll 61727 — Ring	<b>H H</b> 91728 — Roll 61728 — Ring	<b>I I</b> 91729 — Roll 61729 — Ring
<b>J J</b> 91730 — Roll 61730 — Ring	<b>K K</b> 91731 — Roll 61731 — Ring	<b>L L</b> 91732 — Roll 61732 — Ring
<b>M M</b> 91733 — Roll 61733 — Ring	<b>N N</b> 91734 — Roll 61734 — Ring	<b>O O</b> 91735 — Roll 61735 — Ring
<b>P P</b> 91736 — Roll 61736 — Ring	<b>Q Q</b> 91737 — Roll 61737 — Ring	<b>R R</b> 91738 — Roll 61738 — Ring
<b>S S</b> 91739 — Roll 61739 — Ring	<b>T T</b> 91740 — Roll 61740 — Ring	<b>U U</b> 91741 — Roll 61741 — Ring
<b>V V</b> 91742 — Roll 61742 — Ring	<b>W W</b> 91743 — Roll 61743 — Ring	<b>X X</b> 91744 — Roll 61744 — Ring
<b>Y Y</b> 91745 — Roll 61745 — Ring	<b>Z Z</b> 91746 — Roll 61746 — Ring	<b>MC MC</b> 91747 — Roll 61747 — Ring



**Barkley® ABKM compatible series**  
1"H x 1-1/2"W (P) (L)  
Roll Unit - 31620 (28 rolls)  
Desktop Kit - 71620 (2,016 labels)

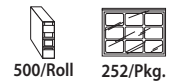

<b>A A</b> 91621 — Roll 71621 — Pkg.	<b>B B</b> 91622 — Roll 71622 — Pkg.	<b>C C</b> 91623 — Roll 71623 — Pkg.	<b>D D</b> 91624 — Roll 71624 — Pkg.	<b>E E</b> 91625 — Roll 71625 — Pkg.
<b>F F</b> 91626 — Roll 71626 — Pkg.	<b>G G</b> 91627 — Roll 71627 — Pkg.	<b>H H</b> 91628 — Roll 71628 — Pkg.	<b>I I</b> 91629 — Roll 71629 — Pkg.	<b>J J</b> 91630 — Roll 71630 — Pkg.
<b>K K</b> 91631 — Roll 71631 — Pkg.	<b>L L</b> 91632 — Roll 71632 — Pkg.	<b>M M</b> 91633 — Roll 71633 — Pkg.	<b>N N</b> 91634 — Roll 71634 — Pkg.	<b>O O</b> 91635 — Roll 71635 — Pkg.
<b>P P</b> 91636 — Roll 71636 — Pkg.	<b>Q Q</b> 91637 — Roll 71637 — Pkg.	<b>R R</b> 91638 — Roll 71638 — Pkg.	<b>S S</b> 91639 — Roll 71639 — Pkg.	<b>T T</b> 91640 — Roll 71640 — Pkg.
<b>U U</b> 91641 — Roll 71641 — Pkg.	<b>V V</b> 91642 — Roll 71642 — Pkg.	<b>W W</b> 91643 — Roll 71643 — Pkg.	<b>X X</b> 91644 — Roll 71644 — Pkg.	<b>Y Y</b> 91645 — Roll 71645 — Pkg.
<b>Z Z</b> 91646 — Roll 71646 — Pkg.	<b>MC MC</b> 91647 — Roll 71647 — Pkg.			

## color code labels

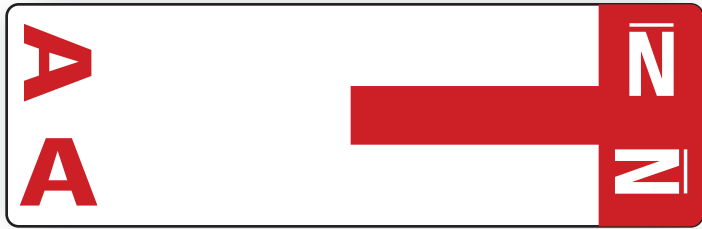

### Smead® NCC compatible series

1-5/32"H x 3-5/8"W (P)

Desktop Kit -

31920 (1,500 labels)



100/Pkg.

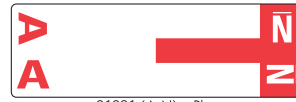

91921 (A-N) - Pkg.



91922 (B-O) - Pkg.

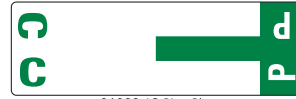

91923 (C-P) - Pkg.



91924 (D-Q) - Pkg.

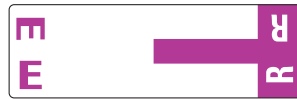

91925 (E-R) - Pkg.



91926 (F-S) - Pkg.



91927 (G-T) - Pkg.



91928 (H-U) - Pkg.

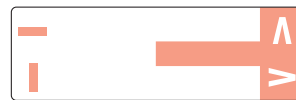

91929 (I-V) - Pkg.

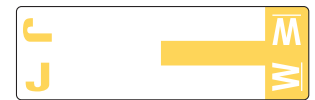

91930 (J-W) - Pkg.

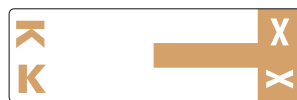

91931 (K-X) - Pkg.

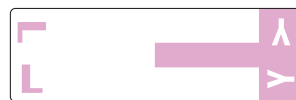

91932 (L-Y) - Pkg.



91933 (M-Z) - Pkg.

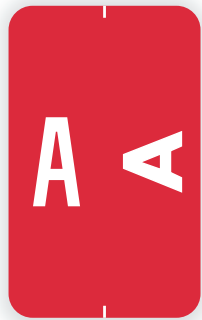

### Smead® ACC & ACCS compatible series

1-5/8"H x 1"W (P) (L)

Roll Unit - 41820 (26 rolls)



250/Roll



108/Pkg.



91821 - Roll  
71821 - Pkg.



91822 - Roll  
71822 - Pkg.



91823 - Roll  
71823 - Pkg.



91824 - Roll  
71824 - Pkg.



91825 - Roll  
71825 - Pkg.



91826 - Roll  
71826 - Pkg.



91827 - Roll  
71827 - Pkg.



91828 - Roll  
71828 - Pkg.



91829 - Roll  
71829 - Pkg.



91830 - Roll  
71830 - Pkg.



91831 - Roll  
71831 - Pkg.



91832 - Roll  
71832 - Pkg.



91833 - Roll  
71833 - Pkg.



91834 - Roll  
71834 - Pkg.



91835 - Roll  
71835 - Pkg.



91836 - Roll  
71836 - Pkg.



91837 - Roll  
71837 - Pkg.



91838 - Roll  
71838 - Pkg.



91839 - Roll  
71839 - Pkg.



91840 - Roll  
71840 - Pkg.



91841 - Roll  
71841 - Pkg.



91842 - Roll  
71842 - Pkg.



91843 - Roll  
71843 - Pkg.



91844 - Roll  
71844 - Pkg.



91845 - Roll  
71845 - Pkg.



91846 - Roll  
71846 - Pkg.



### Smead® BCCS & BCCR compatible series

1"H x 1-1/4"W (P) (L)

Roll Unit - 41020 (28 rolls)



500/Roll



240/Pkg.



91021 - Roll  
TP240-A - Pkg.



91022 - Roll  
TP240-B - Pkg.



91023 - Roll  
TP240-C - Pkg.



91024 - Roll  
TP240-D - Pkg.



91025 - Roll  
TP240-E - Pkg.



91026 - Roll  
TP240-F - Pkg.



91027 - Roll  
TP240-G - Pkg.



91028 - Roll  
TP240-H - Pkg.



91029 - Roll  
TP240-I - Pkg.



91030 - Roll  
TP240-J - Pkg.



91031 - Roll  
TP240-K - Pkg.



91032 - Roll  
TP240-L - Pkg.



91033 - Roll  
TP240-M - Pkg.



91034 - Roll  
TP240-N - Pkg.



91035 - Roll  
TP240-O - Pkg.



91036 - Roll  
TP240-P - Pkg.



91037 - Roll  
TP240-Q - Pkg.



91038 - Roll  
TP240-R - Pkg.



91039 - Roll  
TP240-S - Pkg.



91040 - Roll  
TP240-T - Pkg.



91041 - Roll  
TP240-U - Pkg.



91042 - Roll  
TP240-V - Pkg.



91043 - Roll  
TP240-W - Pkg.



91044 - Roll  
TP240-X - Pkg.



91045 - Roll  
TP240-Y - Pkg.



91046 - Roll  
TP240-Z - Pkg.



91047 - Roll  
TP240-Mc - Pkg.



## color code labels

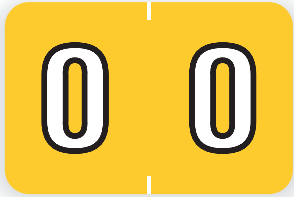

**Colwell® Jewel-Tone compatible series**  
1" H x 1-1/2" W (P)  
Roll Unit – 91410 (28 rolls)



**Barkley® NBKM compatible series**  
1" H x 1-1/2" W (P) (L)  
Roll Unit – 31600 (10 rolls)

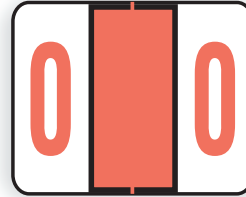

**Smead® BCCRN compatible series**  
1" H x 1-1/4" W (P) (L)  
Roll Unit – (10 rolls)  
71010 (Kimdura)/91010 (Laminated)

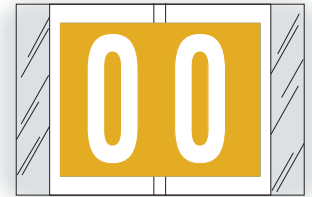

**Original Col'R'Tab® series**  
1" H x 1-1/2" W (P) (L)  
Roll Unit – 41000 (10 rolls)



500/Roll



500/Roll

252/Pkg.

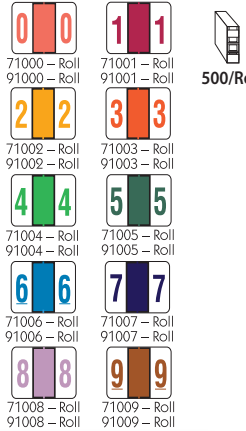

500/Roll

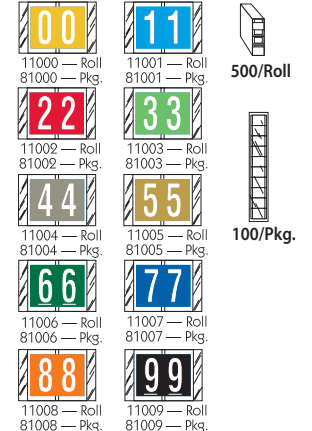

500/Roll

100/Pkg.



**Smead® LCC compatible series**  
2" H x 1" W (P) (L)  
Roll Unit – 41800 (10 rolls)

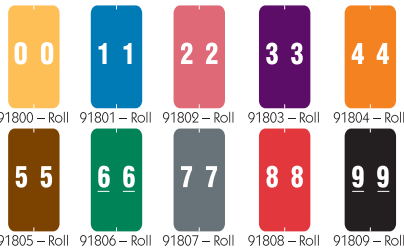

250/Roll

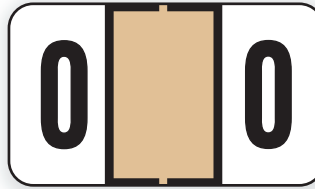

**Jeter® 7300 compatible series**  
15/16" H x 1-5/8" W (P) (L)

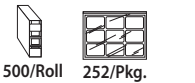

500/Roll 252/Pkg.

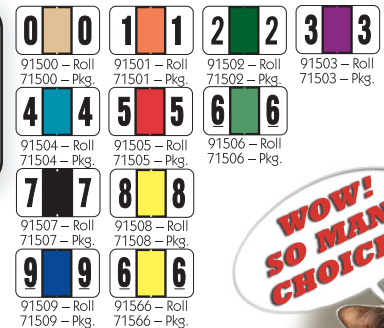

## Additional ALPHABETIC, NUMERIC, MONTHLY & DESIGNATOR LABELS

### ALPHABETIC (\*) (P) (L)

**Col'R'Tab® original series**  
12100 - 500/Roll  
82101 - 100/Pkg.

**Col'R'Tab® original series**  
81950 - 100/Pkg.

**Safeguard® compatible series**  
93020 - 500/Roll  
63020 - 240/Ringbook Pkg.

**POS® compatible series**  
62230 - 150/Ringbook Pkg.

**GBS/VRE® compatible series**  
91320 - 550/Roll  
61320 - 200/Ringbook Pkg.

**Tab Products® compatible series**  
14100 - 500/Roll  
84100 - 100/Pkg.

**Tab Products® compatible series**  
90120 - 500/Roll  
70120 - 252/Pkg.

**Tab Products® compatible series**  
71220 - 500/Roll

**MONTHLY (\*) (P) (L)**  
**Tabbies® original series**  
70230 - 100/Pkg.  
**Col'R'Tab® original series**  
11880 - 100/Pkg.

### NUMERIC (\*) (P) (L)

**Ames® compatible series**  
94900 - 500/Roll

**Col'R'Tab® original series**  
11500 - 500/Roll  
81500 - 100/Pkg.

**Col'R'Tab® original series**  
11050 - 500/Roll

**DigiKolor® series Col'R'Tab® original**  
14560 - 500/Roll

**Tabbies® original series**  
90100 - 500/Roll  
70100 - 252/Pkg.

**GBS/VRE® compatible series**  
91300 - 550/Roll

**Tab Products® compatible series**  
14000 - 500/Roll

**Tab Products® compatible series**  
91100 - 500/Roll  
71100 - 252/Pkg.

### DESIGNATOR (\*) (P) (L)

**Tabbies® original series**  
70520 - 252/Pkg.

**Jeter® 9500 compatible series**  
91980 - 500/Roll

**Col'R'Tab® original series**  
11600 - 500/Roll

**Col'R'Tab® original series**  
11100 - 500/Roll  
81100 - 100/Pkg.

## year code labels

**Acme Visible® compatible series**  
3/4"H x 1-1/2"W • 1,000 / Roll (\*) (P) (L)

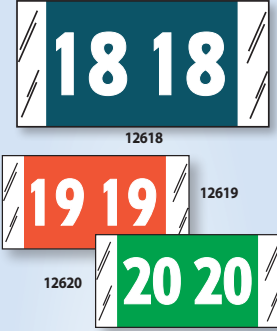

**Ames® compatible series**  
1-7/8"H x 1-7/8"W • 500 / Roll (\*) (P) (L)

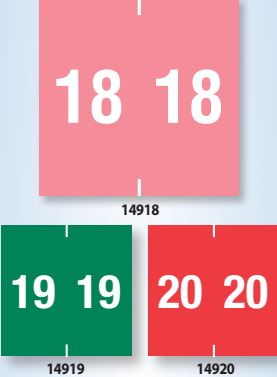

**Barkley® compatible series**  
3/4"H x 1-1/2"W • 500 / Roll (\*) (P) (L)

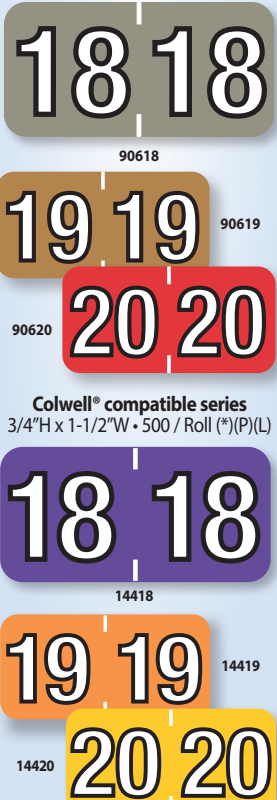

**Colwell® compatible series**  
3/4"H x 1-1/2"W • 500 / Roll (\*) (P) (L)



**Digi-Kolor® series (original Col'R Tab®)**  
3/4"H x 1-1/2"W • 1,000 / Roll (\*) (P) (L)

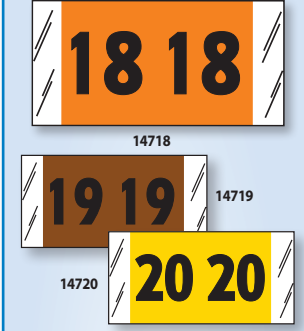

**GBS®/VRE® compatible series**  
3/4"H x 1-1/2"W • 500 / Roll (\*) (P) (L)

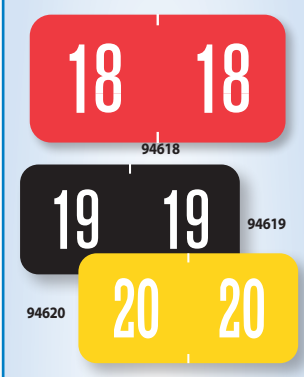

**Jeter® compatible series**  
3/4"H x 1-1/2"W • 500 / Roll (\*) (P) (L)

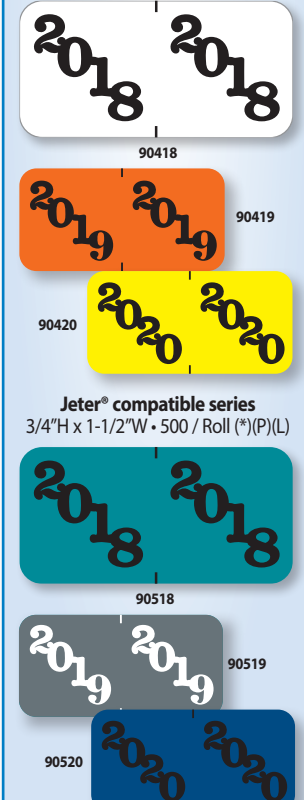

**Jeter® compatible series**  
3/4"H x 1-1/2"W • 500 / Roll (\*) (P) (L)

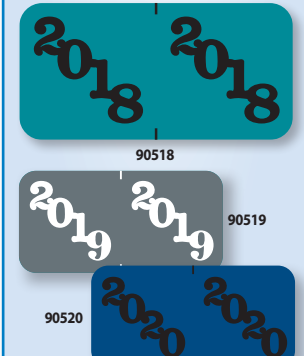

**Col'R Tab® original series**

3/4"H x 1-1/2"W (\*) (P) (L)  
11718, 11719, 11720 - 1,000 / Roll  
51718, 51719, 51720 - 500 / Roll  
81718, 81719, 81720 - 250 / Pkg.



**Col'R Tab® original series**  
1-1/2"H x 3/4"W • 1,000 / Roll (\*) (P) (L)

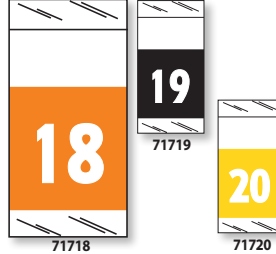

**Tabbies® original series**  
3/4"H x 1-1/2"W • 500 / Roll (\*) (P) (L)



**Tabbies® original series**  
1"H x 1/2"W • 250 / Pkg. (\*) (P) (L)

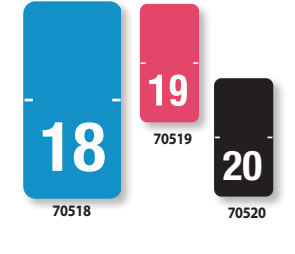

**SFI® compatible series**

3/4"H x 1-1/2"W • 1,000 / Roll (\*) (P) (L)

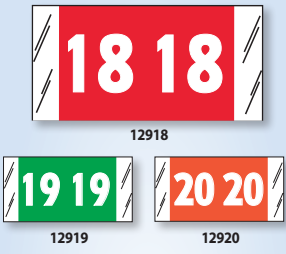

**Smead®/Jeter® compatible series**  
3/4"H x 1-1/2"W • 500 / Roll (\*) (P) (L)



**Smead® compatible series**  
1/2"H x 1"W (\*) (P) (L)



**Smead® compatible series**

1"H x 1/2"W • 500 / Roll (\*) (P) (L)



**Tab Products® compatible series**  
3/4"H x 1-1/2"W • 500 / Roll (\*) (P) (L)



**Tab Products® compatible series**  
1/2"H x 1-1/8"W • 500 / Roll (\*) (P) Kimdura

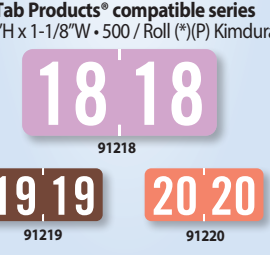

## laser/inkjet file folder labels

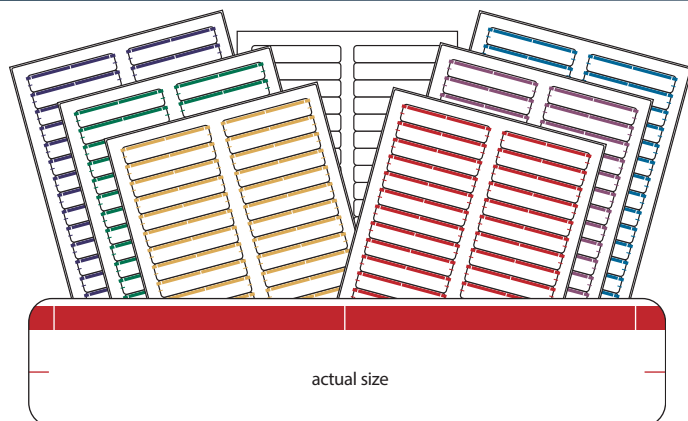

**laser / inkjet file folder labels** are easy to use with most label software. The paper and adhesive are formulated specifically for use in laser or inkjet printers. 750 labels per package. Labels are 2-up per page.

Overall sheet size: 8-1/2" w x 11" h. Label size: 3-7/16" w x 2/3" h – Color bar or White. Compatible to Avery Labels #5366

stock no.	color	labels/sheet	sheets/pkg.
49430	White	30	25
49431	Light Blue	30	25
49432	Red	30	25
49436	Green	30	25
49437	Dark Blue	30	25
49441	Tan	30	25
49443	Purple	30	25

## laser/inkjet label sheets

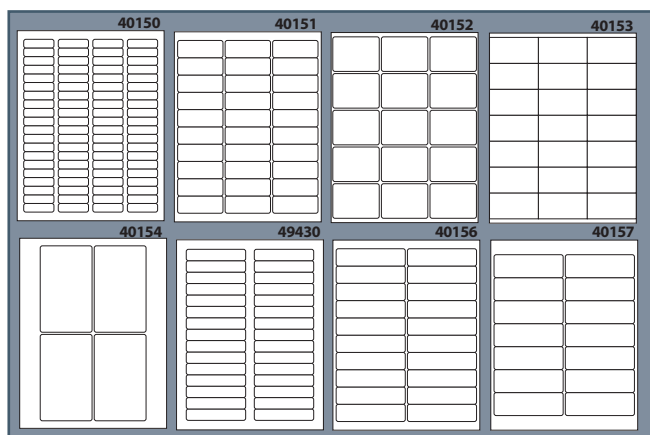

Multi-use **laser/inkjet label sheets** are useful for mailings, announcements, getting organized, tracking or recalling documents in legal proceedings and more. Labels are easy to apply for convenient, personalized labels anytime. Sheets are shrink-wrapped in packages and are fully compatible with both laser and inkjet printers. Labels feed automatically from paper tray and are centered on sheets so they can be fed using either the top or bottom as the lead edge. See your printer manual for additional feeding instructions.

stock no.	label size	labels/sheet	Avery® match	total labels
40150	1-3/4" x 1/2"	80	5167	8,000
40151	2-5/8" x 1"	30	5160	3,000
40152	2-11/16" x 2"	15	6490	1,500
40153	2-13/16" x 1-1/2"	21	-	2,100
40154	3" x 5"	4	-	400
49430	3-7/16" x 2/3"	30	5366	750
40156	4" x 1"	20	5161	2,000
40157	4" x 1-1/3"	14	5162	1,400

## labels-u-create



Create bright, eye-catching communication labels in seconds, using your PC and laser printer with **labels-u-create** to make custom labels for any application. Permanent labels can be applied to folders, documents, drawers, even shelving. Make an entire sheet of the same label or just a few at a time. Easy set-up instructions inside. Works with Microsoft® Word. No additional software is needed. 10 (8-1/2"x11") sheets per package. See below for available colors and sizes.

stock no.	label size	color	labels/sheet	labels/pkg.	stock no.	label size	color	labels/sheet	labels/pkg.
40100	1-1/2" X 7/8"	White	32	320	40122	1-1/2" X 1-1/2"	Fl-Green	20	200
40101	1-1/2" X 7/8"	Fl-Red	32	320	40123	1-1/2" X 1-1/2"	Fl-Yellow	20	200
40102	1-1/2" X 7/8"	Fl-Green	32	320	40140	3-1/4" X 1-3/4"	White	10	100
40103	1-1/2" X 7/8"	Fl-Yellow	32	320	40141	3-1/4" X 1-3/4"	Fl-Red	10	100
40120	1-1/2" X 1-1/2"	White	20	200	40142	3-1/4" X 1-3/4"	Fl-Green	10	100
40121	1-1/2" X 1-1/2"	Fl-Red	20	200	40143	3-1/4" X 1-3/4"	Fl-Yellow	10	100

## erasable write-on index tabs



**erasable write-on index tabs** can be used over and over again. Write with pencil or any erasable ink pen – then just erase and reuse. Tabs have 1/2" tab extension with colored edges. Ideal for any filing, flagging or indexing situation.

stock no.	tab size	color edge	tabs/pkg.	pkgs./box	stock no.	tab size	color edge	tabs/pkg.	pkgs./box
58700	1-1/2"	Yellow	16	10	58707	1-1/2"	Blue	16	10
58702	1-1/2"	Red	16	10	58709	1-1/2"	Black	16	10
58706	1-1/2"	Green	16	10	58710	1-1/2"	White	16	10

# INDEX

Animal Alert Cards.....2  
 Custom Index Dividers.....11  
 Fasteners – File Folders.....12  
 File Folders.....11-12  
 Marketing & Client Giveaways.....2  
  
 Medical Record Sheets.....4  
 Pockets – File.....13  
 Self-Adhesive Dividers.....12

LABELS  
 Allergy Warning.....4  
 Alphabetic.....14-17  
 Annual Visit.....6  
 Authorization & Consent.....5  
 Billing & Collection.....10  
 Care Instructions.....2-3  
 CovRTabs.....13  
 Dental Examination Records.....6  
 Designator.....17  
 Drug Syringe.....9  
 Erasable Write-on Index Tabs.....19  
 Examination Records.....6-7  
 Inventory Control & Sterilization.....5  
 IV/Medication Added.....9  
 Labels-U-Create.....19

LABELS (cont.)  
 Laboratory.....8  
 Laser/Inkjet.....19  
 Medication Dispensing.....10  
 Medication Instruction.....10  
 Monthly.....17  
 Name.....19  
 Numeric.....17  
 Pathology.....8  
 Physical Examination.....7  
 Protectors – File Folder.....13  
 Urinalysis.....8  
 Vaccination Records.....5  
 X-Ray.....5  
 Year Code Labels.....18



**www.tabbies.com**  
**www.tabbiescustomlabels.com**



*Family owned & operated  
 since 1955*

Manufacturer #084371

## OTHER CATALOGS AVAILABLE:

- Custom Label and Print Guide
- Filing, Indexing & Labeling Products
- Healthcare Filing, Indexing & Labeling Products
- Religious Products
- Shipping & Handling Products